



DIGITAL FIBER SENSOR

FX-301(P)(-HS)/305(P)

PRO Mode Operation Guide

For the operation method of **FX-301B/G/H**, refer to 'Digital fiber sensor **FX-301/302/303** series PRO mode operation guide' on the SUNX home page (<http://www.sunx.co.jp>).

INDEX

1. Functional Description	6. PRO2 Mode
1-1. Functional Description.....P.1	6-1. PRO2 Mode Functions and SettingsP.35
1-2. Setting Procedure.....P.1	6-2. Digital Display Setting FunctionP.37
2. Diagram of Functions and Settings	6-3. Digital Display Inversion FunctionP.38
2-1. Diagram of Functions and Settings.....P.2	6-4. ECO Mode Setting FunctionP.39
3. Others	7. PRO3 Mode
3-1. Precautions When Selecting Settings.....P.3	7-1. PRO3 Mode Functions and Settings...P.40
3-2. Factory SettingsP.4	7-2. Data Bank Load Setting FunctionP.41
3-3. Error Display Indicator ReadingsP.4	7-3. Data Bank Save Setting FunctionP.42
3-4. Introducing FX-301(P) Updated Version Unit ..P.5	8. PRO4 Mode
4. Settings for NAVI Mode	8-1. PRO4 Mode Functions and Settings...P.43
4-1. NAVI Mode Functions and SettingsP.6	8-2. Setting Contents Copy FunctionP.44
4-2. Teaching Mode	8-3. Remote Data Bank Load Setting Function ..P.45
[when using FX-301(P)(-HS) or FX-305(P) normal mode] P.10	8-4. Remote Data Bank Save Setting Function ..P.46
4-3. Teaching Mode	8-5. Selection for Communication Change to Permit / Not to Permit..P.47
[when using FX-305(P) window comparator mode] P.13	8-6. Backup Setting FunctionP.48
4-4. Threshold Value Fine Adjustment Mode	9. PRO5 Mode
[when using FX-301(P)(-HS) or FX-305(P) normal mode] P.19	9-1. PRO5 Mode Functions and Settings.....P.49
4-5. Threshold Value Fine Adjustment Mode	9-2. Code Setting Function.....P.51
[when using FX-305(P) window comparator mode]P.20	9-3. Adjust Lock FunctionP.52
4-6. Output Operation Setting ModeP.22	9-4. Setting Reset FunctionP.53
4-7. Timer Operation Setting ModeP.23	9-5. Interference Prevention Switching Function [FX-305(P) only].....P.54
5. PRO1 Mode	10. PRO6 Mode [FX-305(P) only]
5-1. PRO1 Mode Functions and Settings.....P.24	10-1. PRO6 Mode Functions and SettingsP.55
5-2. Response Time Change Function.....P.27	10-2. Output 1 Sensing Mode SettingsP.56
5-3. Timer Setting Function [FX-301(P)(-HS)]P.28	10-3. Output 2 Sensing Mode SettingsP.58
5-4. Timer Setting Function [FX-305(P)]....P.29	11. Others
5-5. Hysteresis Function.....P.31	11-1. Key Lock FunctionsP.59
5-6. Stability FunctionP.32	11-2. Threshold Value Confirmation Function..P.59
5-7. Shift FunctionP.33	
5-8. Light Emitting Amount Selection Function ..P.34	

1 Functional Description

1-1. Functional Description

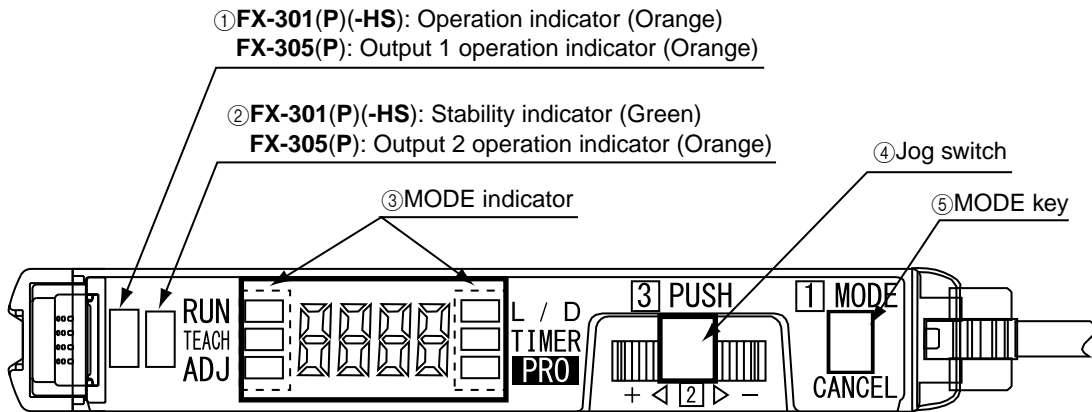

1, **2** and **3** are in the correct order for selecting settings.

- ① Operation indicator (Orange) ... **FX-301(P)(-HS)** : Lights up when output is ON.
 Output 1 operation indicator (Orange) ... **FX-305(P)** : Lights up when output 1 is ON.
- ② Stability indicator (Green) ... **FX-301(P)(-HS)** : Lights up when the incident light intensity is great enough for stable operation.
 Output 2 operation indicator (Orange) ... **FX-305(P)** : Lights up when output 2 is ON.
- ③ MODE indicator ... **RUN (Green)** : Lights up during normal sensing operation.
TEACH (Yellow) : When this indicator lights up, the 'threshold value' can be set by utilizing either '2-level teaching', 'limit teaching' or 'full-auto teaching'. When the **FX-305(P)** is in window comparator mode, the 'threshold value' can be set by either '1-level teaching', '2-level teaching' or '3-level teaching' whenever this indicator lights up.
ADJ (Yellow) : When this indicator lights up, fine adjustment of the 'threshold value' can be performed.
L/D (Yellow) : When this indicator lights up, the output operation can be set.
TIMER (Yellow) : When this indicator lights up, timer operation can be set. (Timer period can be set in PRO1 mode.)
PRO (Yellow) : When this indicator lights up, further advanced functions, such as the copying and memory functions, can be set.
- ④ Jog switch ... Turning this switch in the '+' or '-' direction, allows different items to be viewed for selection and pressing the switch then confirms the selected setting.
- ⑤ MODE key ... This key is used to select operating modes and to cancel settings during the configuration process.

1-2. Setting Procedure

The [MODE key] and [Jog switch] are utilized to configure various settings.

1 Press the [MODE key] (mode selection / cancellation)

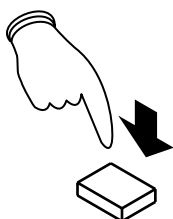

2 Turn the [Jog switch] in the '+' or '-' direction (chooses setting for selection)

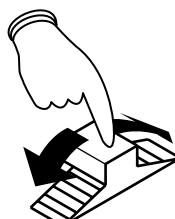

3 Press the [Jog switch] (confirms the selected setting)

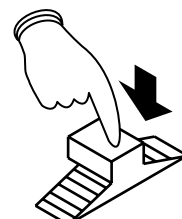

Cancel: If the [MODE key] is pressed, the unit will return to the previous settings status, immediately before the [Jog switch] was pressed (the selected setting has been confirmed).

Selection and confirmation of settings are performed according to the order of the numbers, as shown on the amplifier: 1, 2 and 3.

2 Diagram of Functions and Settings

2-1. Diagram of Functions and Settings

The amplifier features and settings are generally classified into two main modes; the 'NAVI mode' for items and settings that are frequently reconfigured, and the 'PRO mode' that contains more detailed settings.

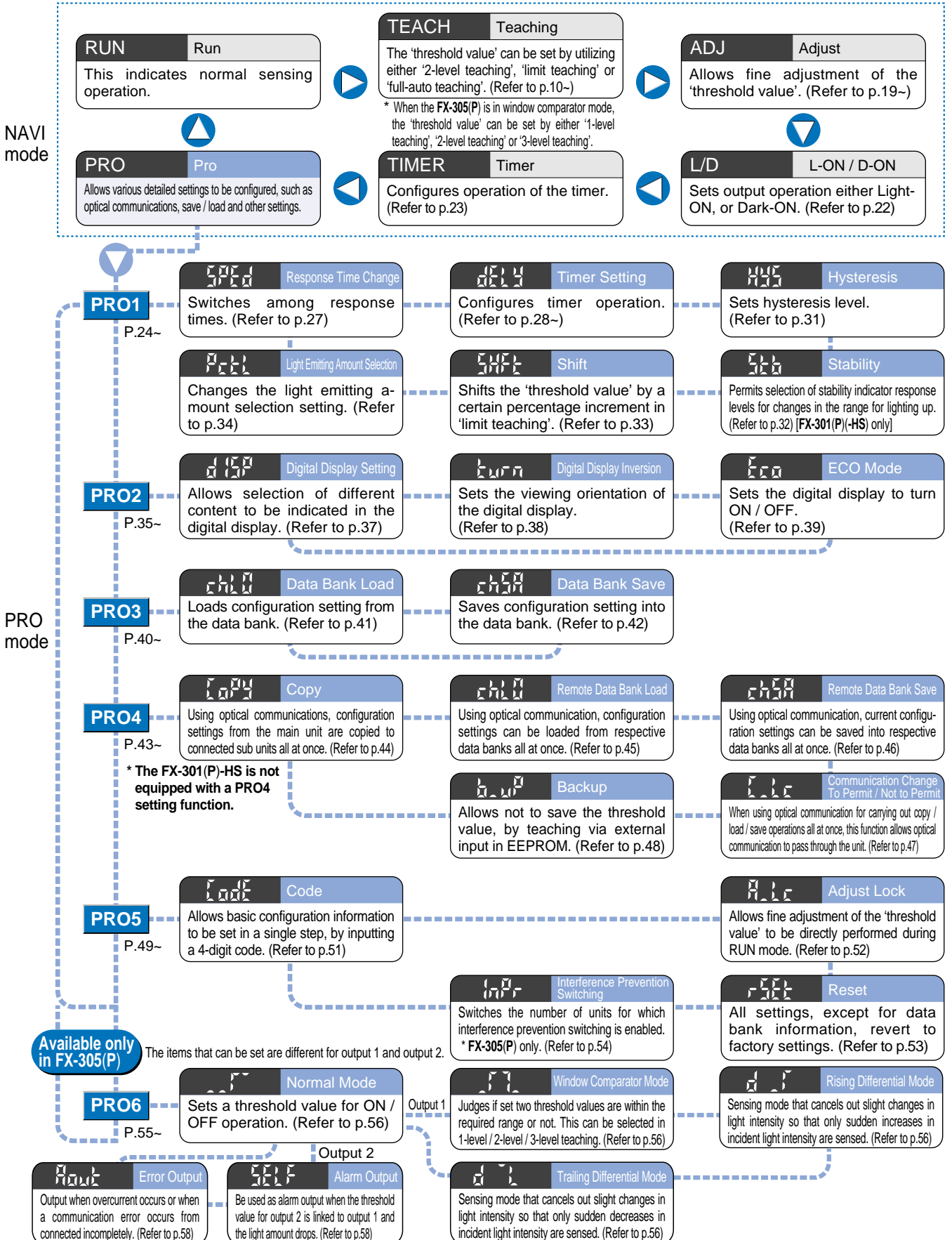

3 Others

3-1. Precautions When Selecting Settings

Canceling operations

- To cancel any operation, press the [MODE key]. If the [MODE key] is pressed once, the unit will return to the previous settings status immediately before the [Jog switch] was pressed.

Example: When operating in PRO mode.

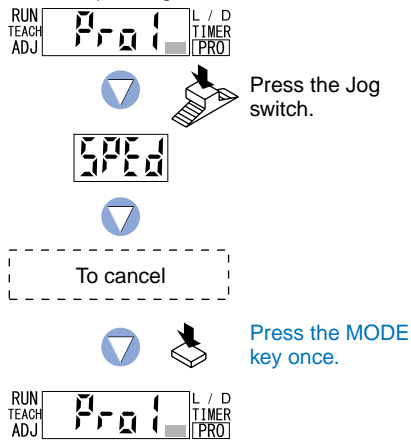

- ① Select 'PRO mode'.
- ② If the [Jog switch] is pressed once, the unit will enter the 'response time change' state.
- ③ To cancel the 'response time change' operation, press the [MODE key] once.
- ④ The display will return to the previous [PRO1 mode] selection screen.

Confirming settings

- When changing the status of any setting, ensure that the selected setting is subsequently confirmed. If confirmation is not performed, the new setting will not take effect.

Example: When setting response time change.
(In case of FX-301)

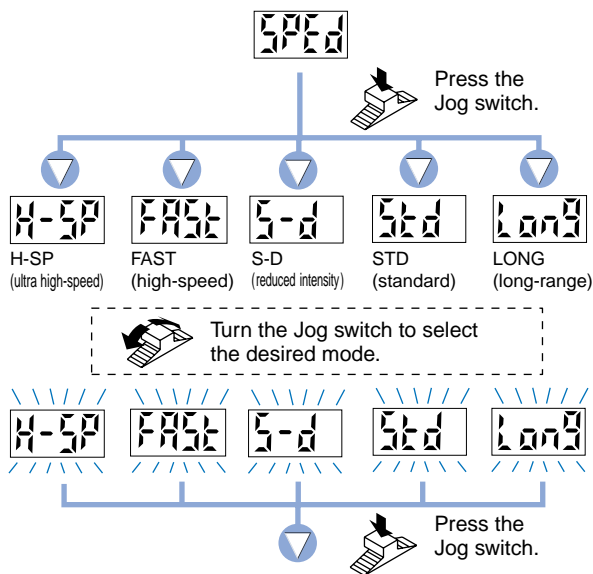

- ① Select 'response time change'.
- ② If the [Jog switch] is pressed, the current mode will be displayed.
* The factory setting is 'STD (standard)'.
- ③ If the [Jog switch] is turned, the digital display will blink.
Select the desired mode.
- ④ If the [Jog switch] is pressed, the digital display will quickly blink 3 times, confirming the setting.

The digital display will quickly blink 3 times to confirm the setting.

Setting protection

- You can use the 'key lock function' to protect settings. (Refer to p.59.)

Key lock function

This function can be used to prevent the operator from accidentally changing the sensor settings.

3-2. Factory Settings

Factory settings for the **FX-301(P)(-HS)/305(P)** are indicated below:

If the unit is reset using the '9-4 Setting Reset Function' from 'PRO5 Mode' on p.53, the resulting settings will be those indicated below:

NAVI mode

Model No.	FX-301(P)-HS		FX-301(P)		FX-305(P)	
	Settings	Digital display	Settings	Digital display	Settings	Digital display
Threshold value	80	80	40	40	Output 1: 80, Output 2: 120	Output 1: 80, Output 2: 120
Light-receiving operation	L-ON (ON when light is received)	L-ON	L-ON (ON when light is received)	L-ON	L-ON (ON when light is received)	L-ON
Timer operation	Without timer	000	Without timer	000	Without timer	000

PRO mode

Model No.	FX-301(P)-HS		FX-301(P)		FX-305(P)	
	Settings	Digital display	Settings	Digital display	Settings	Digital display
Response time	H-SP (ultra high-speed)	H-SP	Standard (standard)	Std	Standard F (standard 2)	StdF
Timer period	10 ms	10	10 ms	10	10 ms	10
Hysteresis	H-02 (standard)	H-02	H-02 (standard)	H-02	H-02 (standard)	H-02
Stability	S-02 (standard)	S-02	S-02 (standard)	S-02	—	—
Shift amount during limit teaching	15 %	15P	15 %	15P	15 %	15P
Light emitting amount selection function	Level 2	001	Level 4 (MAX)	00001	Level 4 (MAX)	00001
Display	Incident light intensity display	d 19t	Incident light intensity display	d 19t	Incident light intensity display	d 19t
Display turning	OFF	OFF	OFF	OFF	OFF	OFF
ECO mode	OFF	OFF	OFF	OFF	OFF	OFF
Selection for transmission change to permit / not to permit	ON	ON	OFF	OFF	OFF	OFF
Backup	—	—	ON	ON	ON	ON
Code	—004	-004	0004	0004	J004	0004
Adjust lock	ON	ON	ON	ON	ON	ON
Interference prevention switching function [FX-305(P) only]	—	—	—	—	IP-1	IP-1
Sensing mode [FX-305(P) only] (Note)	—	—	—	—	Normal mode	Normal mode

Note: In window comparator mode, the factory settings for teaching method is '2-level teaching'.

3-3. Error Display Indicator Readings

In case of errors, attempt the following measures:

FX-301(P)	FX-305(P)	Error description	Measures
Er-1	Er 11 Er 12	The load has short-circuited and excess current is flowing. Er 11: Output 1, Er 12: Output 2	Turn off the power, then check the load.
Er-5	Er-52	Communication error has occurred at time of connection. (In case of using functions of PRO4) mode	Confirm that all amplifiers are properly connected to each other.

3-4. Introducing FX-301(P) Updated Version Unit

Updated version units of the **FX-301(P)** (red LED type) have been manufactured since June 2004. There are some differences in the functions and communication method between these units and previous version units.

Changes in appearance

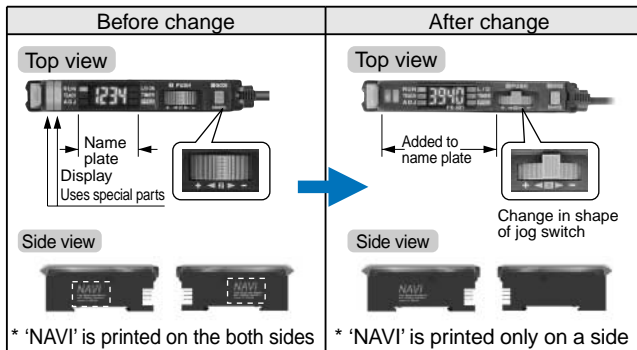

Checking minor changes between previous and new models can be done by checking whether the printing is on both sides or only one side.

Upgraded functions

1. Response times added

An ultra high-speed mode (H-SP) has been added to the existing 4 response time modes [high-speed (FAST), reduced intensity (S-D), standard (STD) and long range (LONG)]. This is changed using 'Pro1' in 'Set'.

Before change	After change
4 steps 150 μs (FAST) 250 μs (S-D) 250 μs (STD) 2 ms (LONG)	5 steps 65 μs (added)(H-SP) 150 μs (FAST) 250 μs (S-D) 250 μs (STD) 2 ms (LONG)

2. Extension of timer period

The setting range for the timer period was previously 500 ms, but this has been extended to a new range of 9999 ms.

3. Light emitting amount selection function

The light emitting amount can be changed to one of 4 levels (5 levels when emission halt is included). However, the number of levels that can be set will vary depending on the response time settings. For further details, refer to p.34.

4. Backup, copy lock and key lock functions added

- Backup** : This selects whether or not threshold values set by teaching are written to (stored in) an EEPROM.
- Copy lock**: This selects whether copy function and data bank function communication are possible or not.
- Key lock** : This disables input using switches to prevent accidental changing of settings.

Changes in operation

1. Timer selection method

Previous version unit: Timer type was changed using PRO1 mode. The 'TIMER' setting in NAVI mode could only be turned on or off.

After change : The type of timer can be changed using the 'TIMER' function in NAVI mode.

2. Checking threshold value in RUN mode

After change: The threshold values can be checked by turning the jog switch.

Display changes

1. Checking blinking of sensitivity margin

The stable margin display method after teaching has been changed. Previous version unit: Sensitivity surplus is indicated by the number of blinks of the stability indicator.



2. Initial direct code value changed

The factory default settings for the direct codes have been changed.

Previous version unit 0000 → **After change 0004**

※ The default setting for the timer period is 10 ms, and the direct code for 10 ms is '4', so this has been changed.

Internal circuit changes

1. Addition of an APC circuit

A four-chemical emitting element which provides stable sensing over long periods has been added, as well as an APC (Auto Power Control) circuit that improves stability during short periods.

Cautions on sensor connection in cascade

- When the units in the group A and the group B shown in the table below are connected in cascade, connect them in cascade as Figure A shown below.

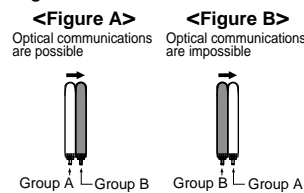

Group A	FX-301(P): Previous version unit, FX-301G(P) / B(P) / H(P), FX-302(P), FX-303(P), LS-400 series (Note 1)
Group B	FX-301(P): Updated version unit, FX-305(P), FX-301(P)-C1

Notes:1) When LS-400 series is connected with the digital fiber amplifier in cascade, be sure to locate LS-400 series at the left-most position (when viewed from the connector side).

- When the units of the group A and the group B are connected in cascade as Figure B shown above, optical communications cannot be done. When the optical communications function is used, connect them as Figure A shown above. If the units cannot be placed as Figure A, the following measure ① or ② should be taken.

- Affix the communication window seal of the accessory amplifier protection seal (FX-MB1) to the communication window of the amplifier.
- If the measure ① described above cannot be taken, change the optical communications spec. of the group B units.

How to change the optical communications spec. of Group B units

- Follow the procedure given below to change the optical communications spec. of the group B units. Be sure to set the optical communications spec. to '3' (the optical communications spec. of the group A) or '0' (stop of the optical communications)'.
 ① Program the sensor to indicate 'PRO4'.
 ② Press the 'jog switch' and the 'MODE key' simultaneously.
 ③ When stop pressing the 'jog switch' and the 'MODE key', the spec. is set and 'PRO4' is indicated.

<Procedure to change>

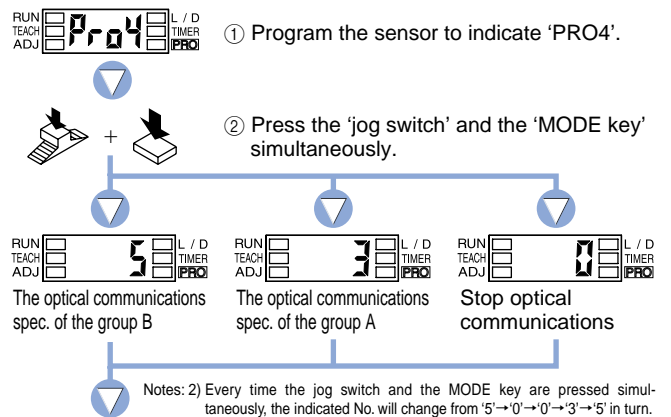

Notes: 2) Every time the jog switch and the MODE key are pressed simultaneously, the indicated No. will change from '5'→'0'→'0'→'3'→'5' in turn.

Notes: 3) When the optical communications spec. is set to '3' (the optical communications spec. of the group A)', be sure to mount the units close together. Furthermore, take care of the following.

- The optical communications function may not be usable due to the environment. etc.
- Do not carry out the collective channel load or save.

4 Settings for NAVI Mode

4-1. NAVI Mode Functions and Settings

In [NAVI mode], frequently changed settings can be easily configured. Settings for four functions can be configured.

RUN : Normal Sensing Operation

This indicates normal sensing operation. Incident light intensity is displayed in real time. The factory setting is that the 'threshold value' cannot be changed directly. When the 'Adjust Lock Function' in 'PRO5 Mode' is disabled, manual fine adjustment of the 'threshold value' can be performed during normal sensing operation. The threshold value can be confirmed by turning the jog switch (Refer to p.59). In addition, key lock function can also be set (Refer to p.59).

Sensing operation



* Sensing operation when 'threshold value' can be fine adjusted



Refer to the section entitled '9-3. Adjust Lock Function' from 'PRO5 Mode' on p.52.

TEACH : Teaching Mode

Refer to p.10 ~ for setting procedure

This mode sets the 'threshold value' by utilizing teaching.

When using FX-301(P)(-HS) or FX-305(P) normal mode

The 'threshold value' can be set with any of the 3 teaching methods, '2-level teaching', 'limit teaching' and 'full-auto teaching'.

2-level Teaching P.10

2-level teaching is a method of setting the threshold value by teaching the amplifier unit two different status conditions - sensing object present and sensing object absent.

The 'threshold value' is usually set using this method.

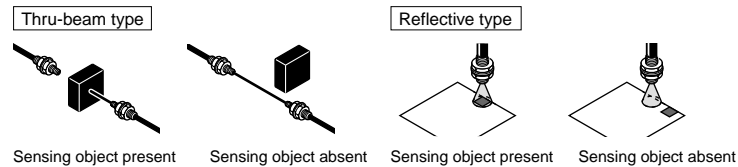

Limit Teaching P.11

Teaches only the status condition in which no sensing object is within sensing range (status in which incident light intensity is stable). This method is used to set a 'threshold value' for conducting sensing in the presence of a background, or when extremely small objects are to be detected.



Full-auto Teaching P.12

This method is used to set the threshold value while the sensing objects are still moving on the production line, without stopping the production line.



TEACH : Teaching Mode

Refer to p.13 ~ for setting procedure

When using FX-305(P) window comparator mode

The 'threshold value' can be set with any of the 3 teaching methods, '1-level teaching', '2-level teaching' and '3-level teaching'. By setting two 'threshold values', both ON and OFF can occur between the two threshold value levels.

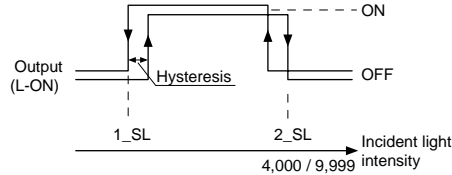

1-level Teaching P.13~

This sets the shift value to any desired value, and sets the threshold values (1_SL, 2_SL) by means of 1-level teaching.

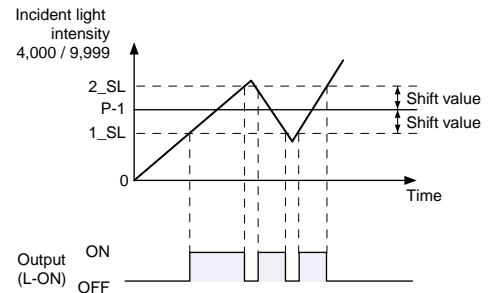
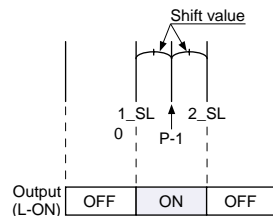

2-level Teaching P.15~

This carries out 2-level teaching (P-1, P-2) and sets the threshold values (1_SL, 2_SL).

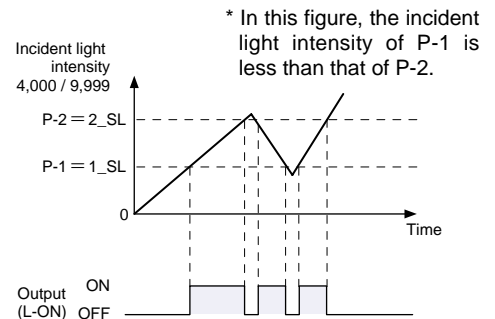
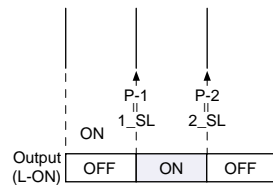

3-level Teaching P.17~

This carries out 3-level teaching (P-1, P-2, P-3) and sets the threshold value (1_SL) between A and B and the threshold value (2_SL) between B and C as shown in the diagram below.

After teaching, P-1, P-2 and P-3 are automatically assigned in ascending order to 'A', 'B', and 'C'.

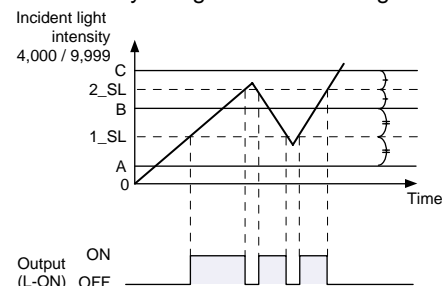
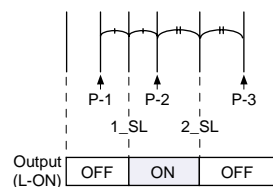

When using FX-305(P) differential mode

Sensing of only sudden changes in incident light intensity is carried out, so that this is ideal for sensing edges of object such as glass.

Set to 'full-auto teaching' if teaching is to be carried out. (Refer to p.12 for details.)

Furthermore, if the response time has been set in STDF, LONG or U-LG mode, mount to make the threshold values to more than the following values.

- STDF mode : 40 digits
- LONG mode : 60 digits
- U-LG mode : 100 digits

ADJ : Threshold Value Fine Adjustment Mode

Refer to p.19~ for setting procedure

This mode allows fine adjustment of the 'threshold value' setting. When the incident light intensity display has been selected, the threshold value can be adjusted in increments as low as a one digit. When the percentage display has been selected, the threshold value can be adjusted in increments of one digit (varies depending on the 'threshold value'). However, when **FX-305(P)** is in window comparator mode, the percentage display function cannot be utilized.

* The factory setting is; **FX-301(P)**: 40, **FX-301(P)-HS**: 80, **FX-305(P)** output 1: 80, **FX-305(P)** output 2: 120.

L/D: Output Operation Setting Mode

Refer to p.22 for setting procedure

This mode allows the selection of output operation from either L-ON (Light-ON), or D-ON (Dark-ON).

When using FX-301(P)(-HS) or FX-305(P) normal mode

When set to 'L-ON', the output will be ON if the incident light intensity becomes greater than the 'threshold value'.

When set to 'D-ON', the output will be ON if the incident light intensity becomes less than the 'threshold value'.

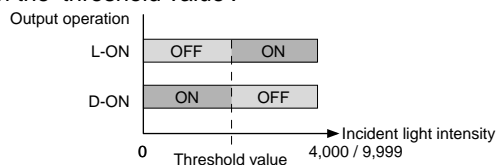

When using FX-305(P) window comparator mode

When set to 'L-ON', if the incident light intensity is between the two 'threshold value' levels, the output will be ON. If the incident light intensity is outside of the two threshold value levels, the output will be OFF.

When set to 'D-ON', if the incident light intensity is between the two 'threshold value' levels, the output will be OFF. If the incident light intensity is outside of the two threshold value levels, the output will be ON.

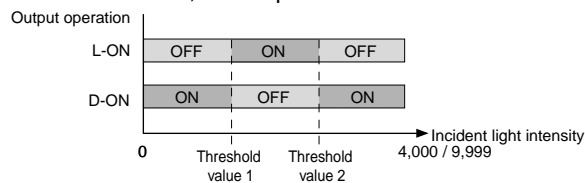

* The factory setting is L-ON (Light-ON).

When using rising differential mode

For L-ON, output is ON for a constant period of time when the incident light intensity is rising.

For D-ON, output is OFF for a constant period of time when the incident light intensity is rising.

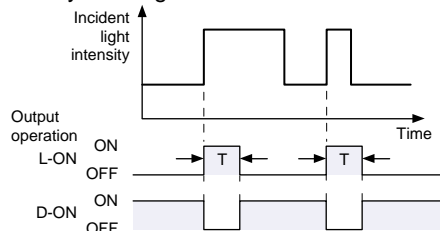

* The output time 'T' can be set by changing the timer period in timer setting mode (initial value: 10 ms).

When using trailing differential mode

For L-ON, output is ON for a constant period of time when the incident light intensity is trailing.

For D-ON, output is OFF for a constant period of time when the incident light intensity is trailing.

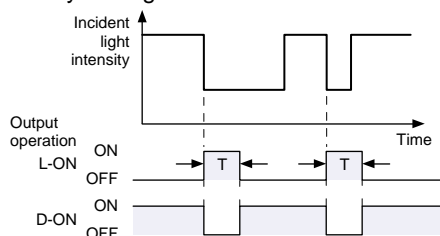

* The output time 'T' can be set by changing the timer period in timer setting mode (initial value: 10 ms).

TIMER : Timer Operation Setting Mode

Refer to p.23 for setting procedure

This mode sets the timer operation and set the type of timer.

For **FX-301(P)(-HS)** the setting can be selected from Without timer / OFF-delay / ON-delay / ONE SHOT timer, and the **FX-305(P)** includes these and also ON-delay • OFF-delay / ON-delay • ONE SHOT timers.

FX-301(P)(-HS)

PRO mode allows the configuration and usage of the following timer operations: OFF-delay / ON-delay / ONE SHOT.

Timer period can be selected from 0.5 ms to 9,999 ms.

Please refer to the section entitled '**5-3. Timer Setting Function [FX-301(P)(-HS)]**' from 'PRO1 Mode' on p.28.

FX-305(P)

PRO mode allows the configuration and usage of the following timer operations: OFF-delay / ON-delay / ONE SHOT / ON-delay • OFF-delay / ON-delay • ONE SHOT.

Timer period can be selected from 0.5 ms to 9,999 ms.

Please refer to the section entitled '**5-4. Timer Setting Function [FX-305(P)]**' from 'PRO1 Mode' on p.29.

4-2. Teaching Mode [when using FX-301(P)(-HS) or FX-305(P) normal mode]

The 'threshold value' can be set by utilizing three kinds of teaching, whichever '2-level teaching', 'limit teaching' or 'full-auto teaching'.

* The factory setting is this mode for **FX-305(P)**. (Refer to p.55)

2-level Teaching

2-level teaching is a method of setting the 'threshold value' by teaching the amplifier two different status conditions - sensing object present and sensing object absent. The 'threshold value' is usually set using this method.

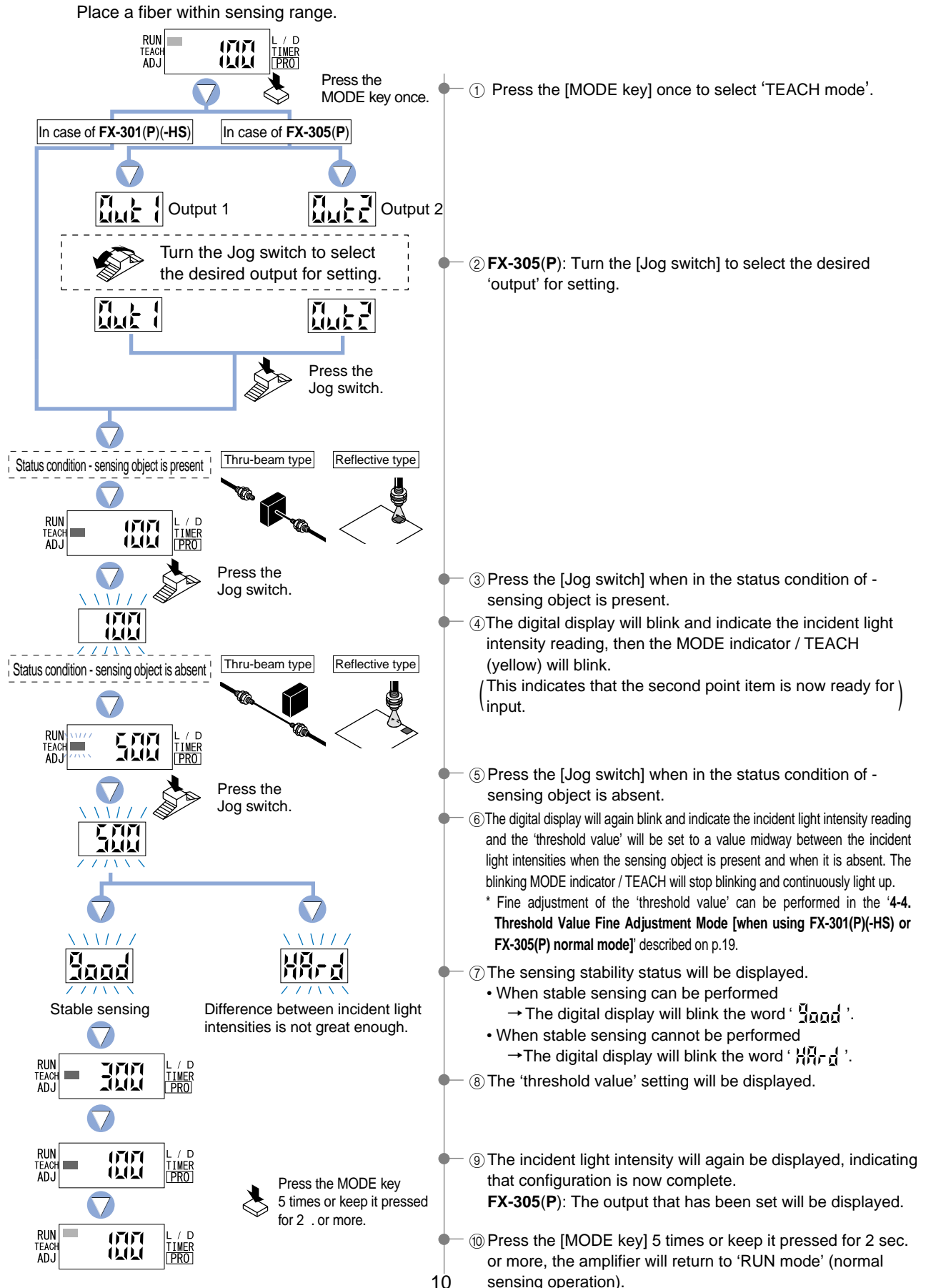

Limit Teaching

Teaches only the status condition in which no sensing object is within sensing range (status in which incident light intensity is stable). This method is used to set a threshold value for conducting sensing in the presence of a background, or when extremely small objects are to be detected.

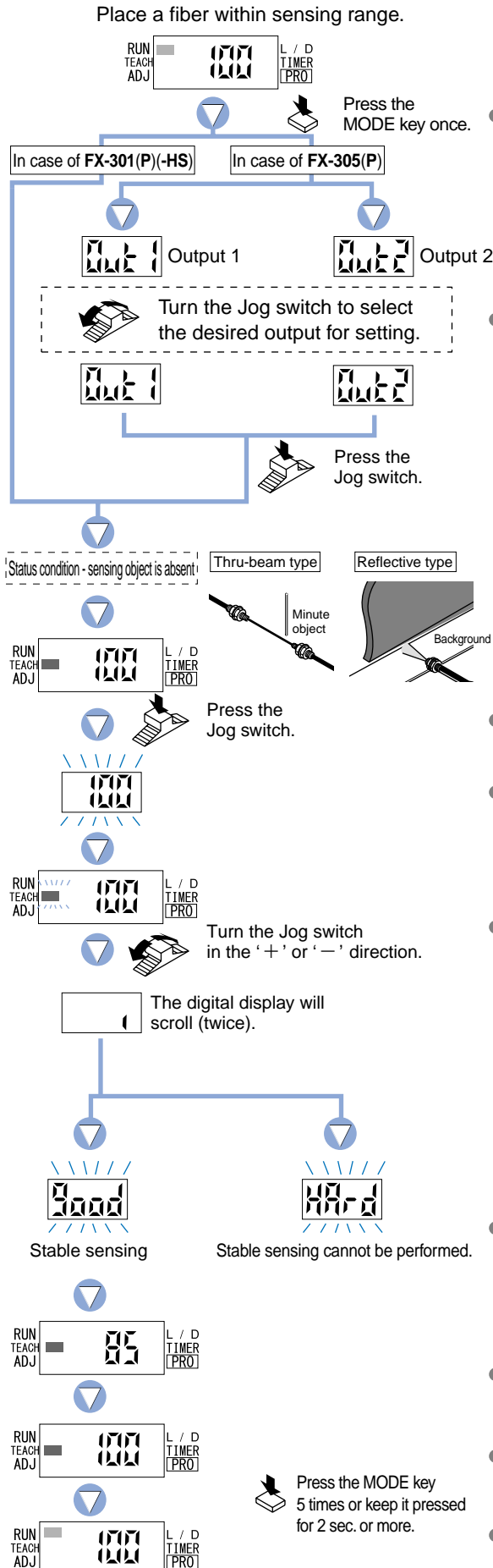

Full-Auto Teaching

Full-auto teaching is used to set the threshold value while the sensing objects are still moving on the production line, without stopping the production line.

* When the **FX-305(P)** is in differential sensing mode, set the threshold value by full-auto teaching. (Refer to p.55)

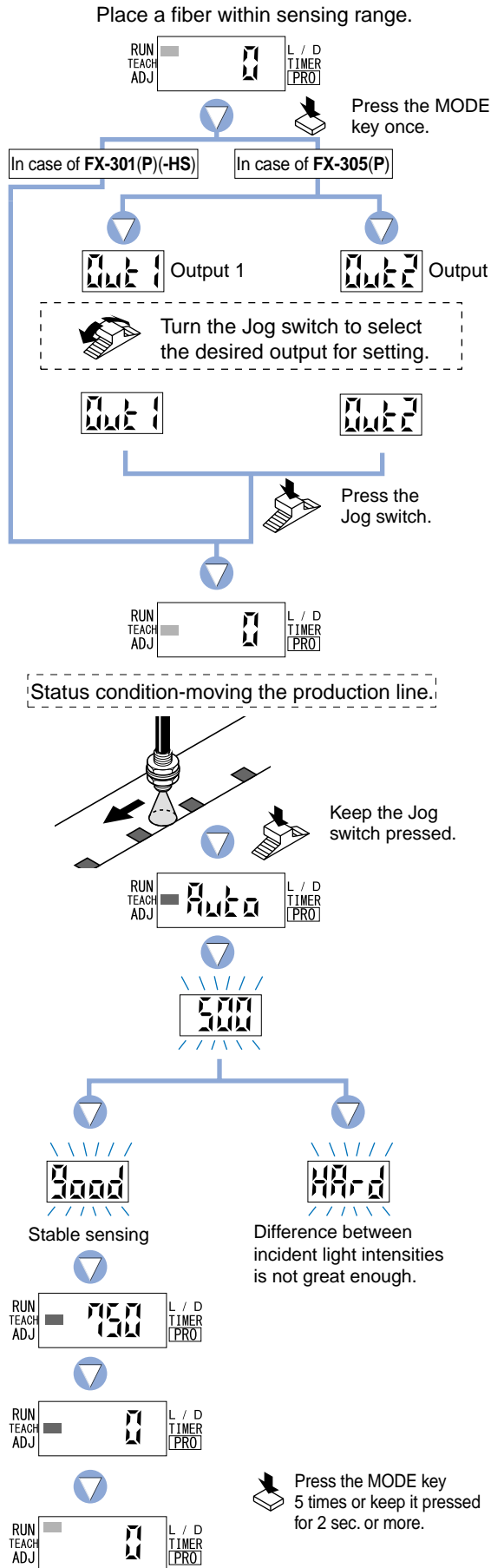

① Press the [MODE key] once to select 'TEACH mode'.

② **FX-305(P)**: Turn the [Jog switch] to select the desired 'output' for setting.

③ In the status condition keep the [Jog switch] pressed for 0.5 sec. or more, when the object is moving on the production line.

④ 'Auto' is displayed on the display.
Release the jog switch when the object has passed.
* The incident light intensity is read when 'Auto' is displayed.

⑤ The threshold value is set to a value midway between the incident light intensities in the object present and object absent conditions.

⑥ The sensing stability status will be displayed.

- When stable sensing can be performed
→ The digital display will blink the word 'Good'.
- When stable sensing cannot be performed
→ The digital display will blink the word 'NG-d'.

⑦ The 'threshold value' setting will be displayed.

⑧ The incident light intensity will again be displayed, indicating that configuration is now complete.

⑨ Press the [MODE key] 5 times or keep it pressed for 2 sec. or more, the amplifier will return to 'RUN mode' (normal sensing operation).

4-3. Teaching Mode [when using FX-305(P) window comparator mode]

The 'threshold value' can be set using '1-level teaching', '2-level teaching' or '3-level teaching'. When FX-305(P) is in window comparator mode, teaching is performed using the teaching methods described in the section entitled '10-2. Output 1 Sensing Mode Settings' from 'PRO6 Mode' on p.56. To change the teaching method, follow the procedures also described under the same heading.

- * Window comparator mode can be set for output 1 only.
- * The factory setting is '1-level teaching (1LCH)'.

1-level Teaching

This is the method of setting the threshold values (1_SL, 2_SL) by one level (P-1) teaching. The shift value can be set as desired.

- * The shift value units can be selected from two units: 'digit' or '%'.
- * The shift value of the factory setting is set to '100' of 'digit' units. To set the shift value, refer to the section entitled '10-2. Output 1 Sensing Mode Settings' from 'PRO6 Mode' on p.56.

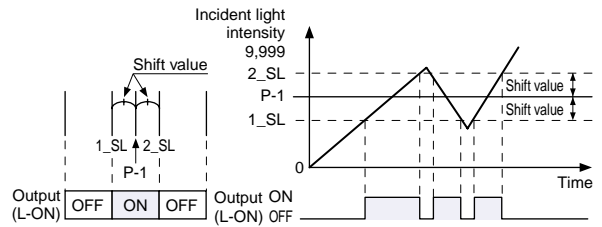

Setting in PRO6 mode beforehand

For further details, refer to '10-2. Output 1 Sensing Mode Settings' on p.56.

<p>RUN TEACH ADJ</p> <p>L / D TIMER PRO</p>	<p>Press the MODE key 5 times.</p>	<p>① Press the [MODE key] 5 times to select 'PRO mode'.</p>
<p>RUN TEACH ADJ</p> <p>L / D TIMER PRO</p>	<p>Turn the Jog switch 6 times toward the '+' direction.</p>	<p>② Turn the [Jog switch] 6 times towards the '+' direction to select 'PRO mode'.</p>
<p>RUN TEACH ADJ</p> <p>L / D TIMER PRO</p>	<p>Turn the Jog switch to select output 1.</p>	<p>③ Turn the [Jog switch] to select 'output 1', and then press the [Jog switch] to confirm the setting.</p>
<p>RUN TEACH ADJ</p> <p>L / D TIMER PRO</p>	<p>Turn the Jog switch to select window comparator mode.</p>	<p>④ Turn the [Jog switch] to select 'window comparator mode', and then press the [Jog switch] to confirm the setting.</p>
<p>RUN TEACH ADJ</p> <p>L / D TIMER PRO</p>	<p>Turn the Jog switch to select 1-level teaching.</p>	<p>⑤ Turn the [Jog switch] to select '1-level teaching', and then press the [Jog switch] to confirm the setting.</p>
<p>RUN TEACH ADJ</p> <p>L / D TIMER PRO</p>	<p>Press the MODE key 3 times or keep it pressed for 2 sec. or more.</p>	

Setting in NAVI mode

<p>RUN TEACH ADJ</p> <p>L / D TIMER PRO</p>	<p>Press the MODE key once.</p>	<p>① Press the [MODE key] once to select 'TEACH mode'.</p>
<p>RUN TEACH ADJ</p> <p>L / D TIMER PRO</p>	<p>Press the Jog switch.</p>	<p>② Press the [Jog switch] to select 'output 1'.</p>
<p>RUN TEACH ADJ</p> <p>L / D TIMER PRO</p>	<p>The status condition when a sensing object is present that can be used as a baseline.</p>	<p>③ The current teaching method will be displayed for 0.5 sec., and then the unit will enter the 'P-1' setting state.</p>
<p>RUN TEACH ADJ</p> <p>L / D TIMER PRO</p>	<p>Incident light intensity of P-1.</p>	<p>④ If the [Jog switch] is pressed while in the status condition when a sensing object is present that can be used as a baseline, then the display will blink and indicate the incident light intensity reading.</p>
<p>RUN TEACH ADJ</p> <p>L / D TIMER PRO</p>	<p>Press the Jog switch.</p>	

To be continued on the next page

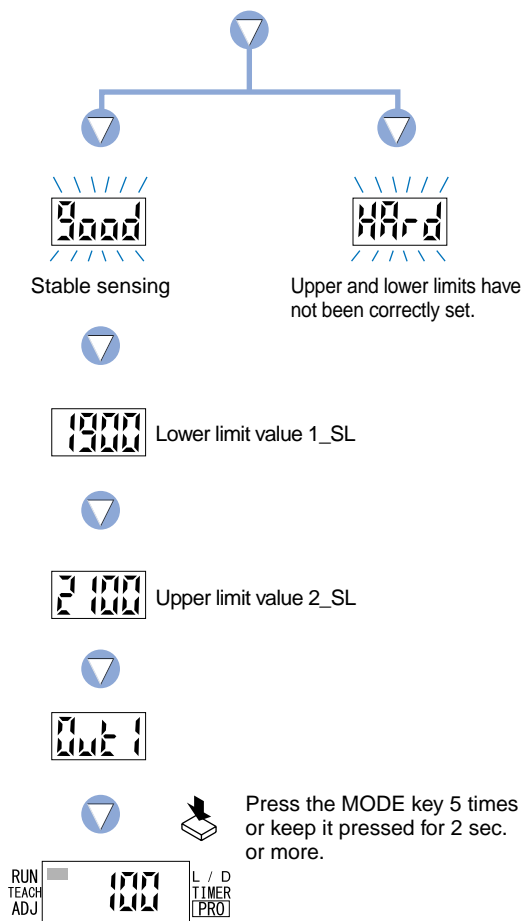

- ⑤ The display will indicate whether the upper and lower threshold value limits have been correctly set or not.
 - If 'Good' is blinking...the upper and lower limits have been set correctly.
 - If 'Err' is blinking...the upper and lower limits have not been set correctly.

* The factory setting for shift value is '100'.
 To set the shift value, refer to the section entitled '10-2. Output 1 Sensing Mode Settings' from 'PRO6 Mode' on p.56.

- ⑥ The setting for 'lower limit value 1_SL' will be displayed.
- ⑦ The setting for 'upper limit value 2_SL' will be displayed.
- ⑧ The output 1 will again be displayed, indicating that configuration is now complete.
- ⑨ Press the [MODE key] 5 times or keep it pressed for 2 sec. or more, the amplifier will return to 'RUN mode' (normal sensing operation).

2-level Teaching

This is a method of setting the threshold values (1_SL, 2_SL) by two levels (P-1, P-2) teaching. Select '2-level teaching (2tch)' in PRO6 mode beforehand.

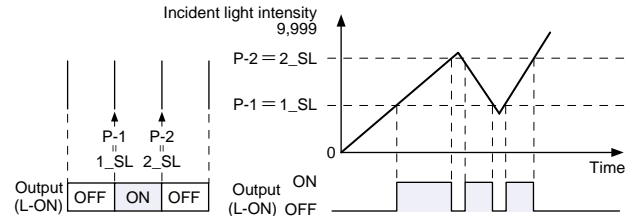

Setting in PRO6 mode beforehand

For further details, refer to '10-2. Output 1 Sensing Mode Settings' on p.56.

<p>RUN TEACH ADJ</p> <p>L / D TIMER [PRO]</p>	<p>Press the MODE key 5 times.</p>	<p>① Press the [MODE key] 5 times to select 'PRO mode'.</p>
<p>RUN TEACH ADJ</p> <p>L / D TIMER [PRO]</p>	<p>Turn the Jog switch 6 times toward the '+' direction.</p>	<p>② Turn the [Jog switch] 6 times towards the '+' direction to select 'PRO mode'.</p>
<p>RUN TEACH ADJ</p> <p>L / D TIMER [PRO]</p>	<p>Turn the Jog switch to select output 1.</p>	<p>③ Turn the [Jog switch] to select 'output 1', and then press the [Jog switch] to confirm the setting.</p>
<p>RUN TEACH ADJ</p> <p>L / D TIMER [PRO]</p>	<p>Turn the Jog switch to select window comparator mode.</p>	<p>④ Turn the [Jog switch] to select 'window comparator mode', and then press the [Jog switch] to confirm the setting.</p>
<p>RUN TEACH ADJ</p> <p>L / D TIMER [PRO]</p>	<p>Turn the Jog switch to select 2-level teaching.</p>	<p>⑤ Turn the [Jog switch] to select '2-level teaching', and then press the [Jog switch] to confirm the setting.</p>
<p>RUN TEACH ADJ</p> <p>L / D TIMER [PRO]</p>	<p>Press the MODE key 3 times or keep it pressed for 2 sec. or more.</p>	

Setting in NAVI mode

<p>RUN TEACH ADJ</p> <p>L / D TIMER [PRO]</p>	<p>Press the MODE key once.</p>	<p>① Press the [MODE key] once to select 'TEACH mode'.</p>
<p>RUN TEACH ADJ</p> <p>L / D TIMER [PRO]</p>	<p>Press the Jog switch.</p>	<p>② Press the [Jog switch] to select 'output 1'.</p>
<p>RUN TEACH ADJ</p> <p>L / D TIMER [PRO]</p>	<p>Press the Jog switch.</p>	<p>③ The current teaching method will be displayed, and then the unit will enter the 'P-1' setting state.</p>
<p>! The status condition when a sensing object is present that can be used as a baseline for the lower limit.</p>		
<p>RUN TEACH ADJ</p> <p>L / D TIMER [PRO]</p>	<p>Press the Jog switch.</p>	<p>④ If the [Jog switch] is pressed while in the status condition when a sensing object is present that can be used as a baseline for the lower limit, then the display will blink and indicate the incident light intensity reading.</p>
<p>RUN TEACH ADJ</p> <p>L / D TIMER [PRO]</p>	<p>Incident light intensity of P-1.</p>	<p>When using thru-beam type fiber</p> <ul style="list-style-type: none"> • Press the [Jog switch] for the sensing object that has the greatest amount of interrupted light. <p>When using reflective type fiber</p> <ul style="list-style-type: none"> • Press the [Jog switch] for the sensing object with the lowest incident light intensity.

To be continued on the next page

Note) Even if procedures ④ and ⑥ are reversed, teaching for a sensing object with low incident light intensity will automatically cause the setting of 'lower limit value 1_SL'.

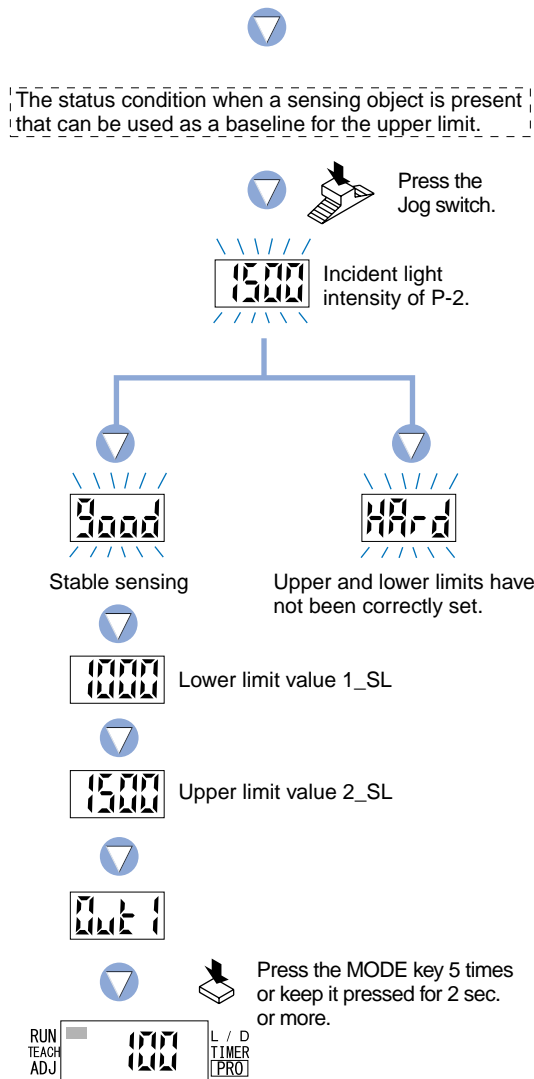

- ⑤ The unit will enter the 'P-2' setting state and 'TEACH' (yellow) will blink on the MODE display.
- ⑥ If the [Jog switch] is pressed while in the status condition when a sensing object is present that can be used as a baseline for the upper limit, then the display will blink and indicate the incident light intensity.
 - When utilizing thru-beam type fiber
 - Press the [Jog switch] for the sensing object that has the least amount of interrupted light.
 - When utilizing reflective type fiber
 - Press the [Jog switch] for the sensing object with the greatest incident light intensity .
- ⑦ The display will indicate whether the upper and lower limits have been correctly set or not.
 - If '9000' is blinking... the upper and lower limits have been set correctly.
 - If 'HA-d' is blinking... the upper and lower limits have not been set correctly.
- ⑧ The setting for 'lower limit value 1_SL' will be displayed.
- ⑨ The setting for 'upper limit value 2_SL' will be displayed.
- ⑩ The output 1 will again be displayed, indicating that configuration is now complete.
- ⑪ Press the [MODE key] 5 times or keep it pressed for 2 sec. or more, the amplifier will return to 'RUN mode' (normal sensing operation).

3-level Teaching

This is a method of setting the threshold range by three levels (P-1, P-2, P-3) teaching and set the threshold values at the middle of 'A' and 'B' (1_SL) and 'B' and 'C' (2_SL). After teaching, P-1, P-2 and P-3 are automatically assigned in ascending order to 'A', 'B', and 'C'. Select '3-level teaching (3Lch)' in PRO6 mode beforehand.

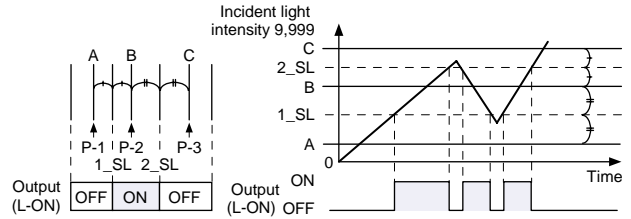

Setting in PRO6 mode beforehand For further details, refer to '10-2. Output 1 Sensing Mode Settings' on p.56.

<p>Press the MODE key 5 times.</p> <p>Turn the Jog switch 6 times toward the '+' direction.</p> <p>Turn the Jog switch to select output 1.</p> <p>Turn the Jog switch to select window comparator mode.</p> <p>Turn the Jog switch to select 3-level teaching.</p> <p>Press the MODE key 3 times or keep it pressed for 2 sec. or more.</p>	<ol style="list-style-type: none"> ① Press the [MODE key] 5 times to select 'PRO mode'. ② Turn the [Jog switch] 6 times towards the '+' direction to select 'PRO mode'. ③ Turn the [Jog switch] to select 'output 1', and then press the [Jog switch] to confirm the setting. ④ Turn the [Jog switch] to select 'window comparator mode', and then press the [Jog switch] to confirm the setting. ⑤ Turn the [Jog switch] to select '3-level teaching', and then press the [Jog switch] to confirm the setting.
---------------------------------------------------------------------------------------------------------------------------------------------------------------------------------------------------------------------------------------------------------------------------------------------------------------------------------------------	--------------------------------------------------------------------------------------------------------------------------------------------------------------------------------------------------------------------------------------------------------------------------------------------------------------------------------------------------------------------------------------------------------------------------------------------------------------------------------------------------------------------------------------------------------------------

Setting in NAVI mode

<p>Press the MODE key once.</p> <p>Output 1</p> <p>Press the Jog switch.</p> <p>The current teaching method will be displayed, and then the unit will enter the 'P-1' setting state.</p> <div style="border: 1px dashed black; padding: 5px; margin: 10px 0;"> <p>The status condition when sensing object 'A' is present that has the lowest incident light intensity.</p> </div> <p>Incident light intensity of P-1.</p> <p>Press the Jog switch.</p>	<ol style="list-style-type: none"> ① Press the [MODE key] once to select 'TEACH mode'. ② Press the [Jog switch] to select 'output 1'. ③ The current teaching method will be displayed, and then the unit will enter the 'P-1' setting state. ④ If the [Jog switch] is pressed while in the status condition when sensing object 'A' is present that has the lowest incident light intensity, then the display will blink and indicate the incident light intensity reading. And then the unit will enter the 'P-2' setting state and 'TEACH' (yellow) will blink on the MODE display. <p>Note) 'P-1', 'P-2' and 'P-3' are set in that order even if procedures ④, ⑤ and ⑥ are changed around.</p>
---------------------------------------------------------------------------------------------------------------------------------------------------------------------------------------------------------------------------------------------------------------------------------------------------------------------------------------------------------------------------------------------------------------------------------------------------------	---------------------------------------------------------------------------------------------------------------------------------------------------------------------------------------------------------------------------------------------------------------------------------------------------------------------------------------------------------------------------------------------------------------------------------------------------------------------------------------------------------------------------------------------------------------------------------------------------------------------------------------------------------------------------------------------------------------------------------------------

To be continued on the next page

The status condition when sensing object 'B' is present that has an incident light intensity in between that of sensing object 'A' and sensing object 'C'.

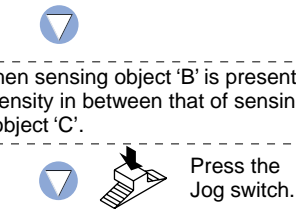

The status condition when sensing object 'C' is present that has the greatest incident light intensity.

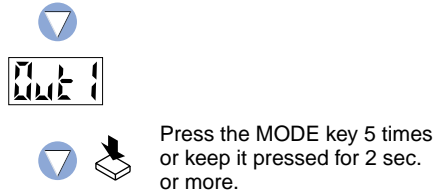
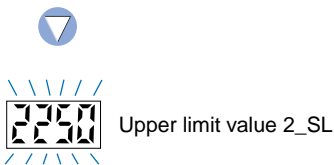
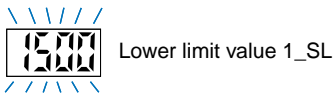
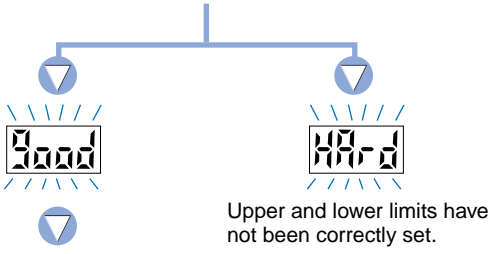
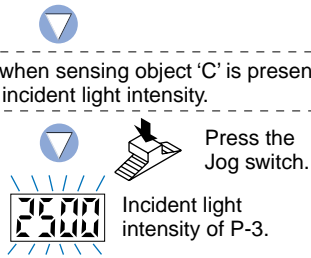

⑤ If the [Jog switch] is pressed while in the status condition when sensing object 'B' is present that has an incident light intensity in between that of sensing object 'A' and sensing object 'C', the display will blink and indicate the incident light intensity reading. And then the unit will enter the 'P-3' setting state.

⑥ If the [Jog switch] is pressed while in the status condition when sensing object 'C' is present that has the greatest incident light intensity, the display will blink and indicate the incident light intensity reading.

⑦ The display will indicate whether the upper and lower limits have been correctly set or not.

- If 'Good' is blinking... the upper and lower limits have been set correctly.
- If 'HA-d' is blinking... the upper and lower limits have not been set correctly.

⑧ The setting for 'lower limit value 1_SL' will be displayed.

⑨ The setting for 'upper limit value 2_SL' will be displayed.

⑩ The output 1 will again be displayed, indicating that configuration is now complete.

⑪ Press the [MODE key] 5 times or keep it pressed for 2 sec. or more, the amplifier will return to 'RUN mode' (normal sensing operation).

4-4. Threshold Value Fine Adjustment Mode [when using FX-301(P)(-HS) or FX-305(P) normal mode]

This mode allows fine adjustment of the 'threshold value' setting.

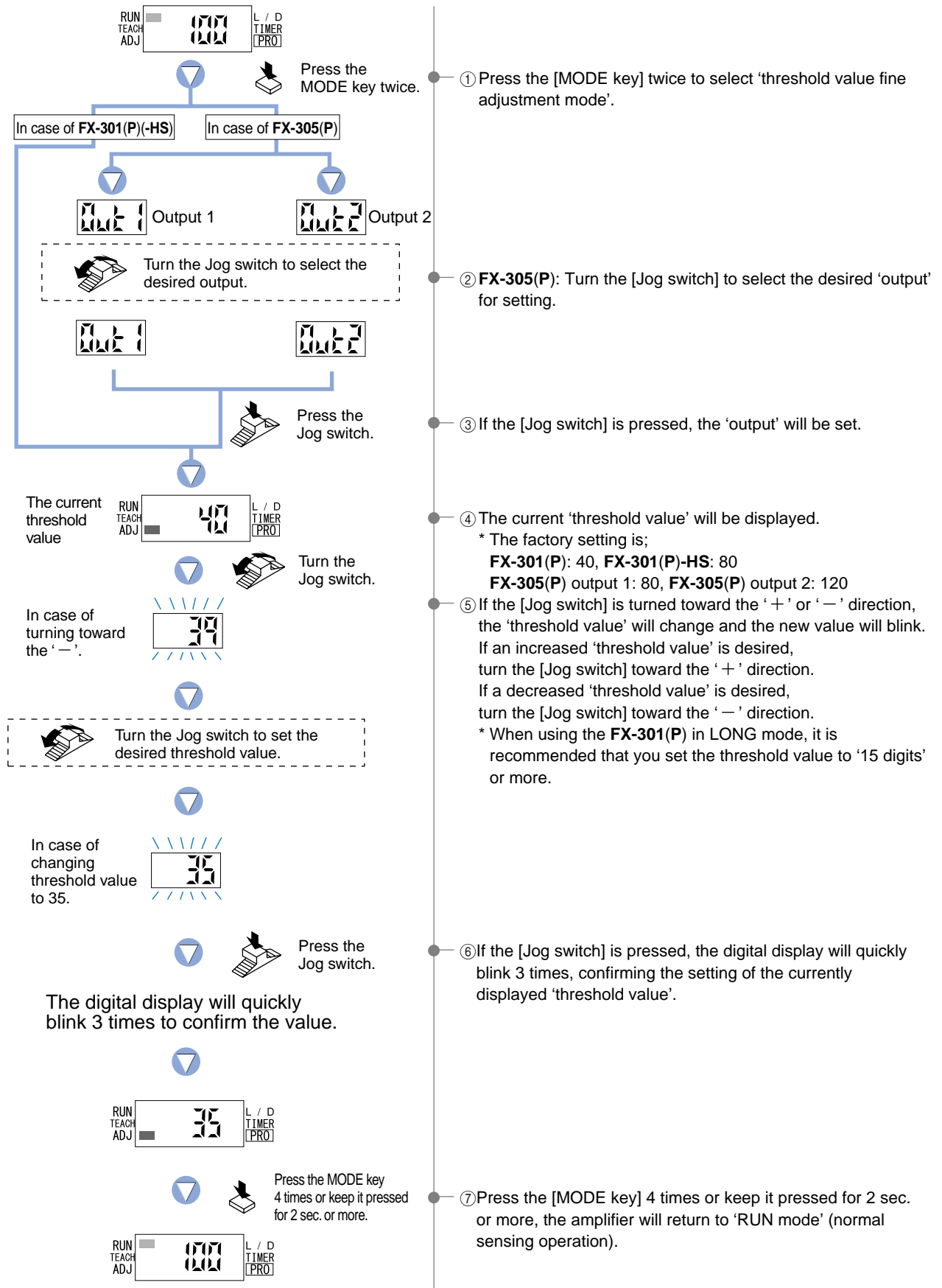

4-5. Threshold Value Fine Adjustment Mode [when using FX-305(P) window comparator mode]

This mode allows fine adjustment of the 'Threshold value (1_SL, 2_SL)' setting.

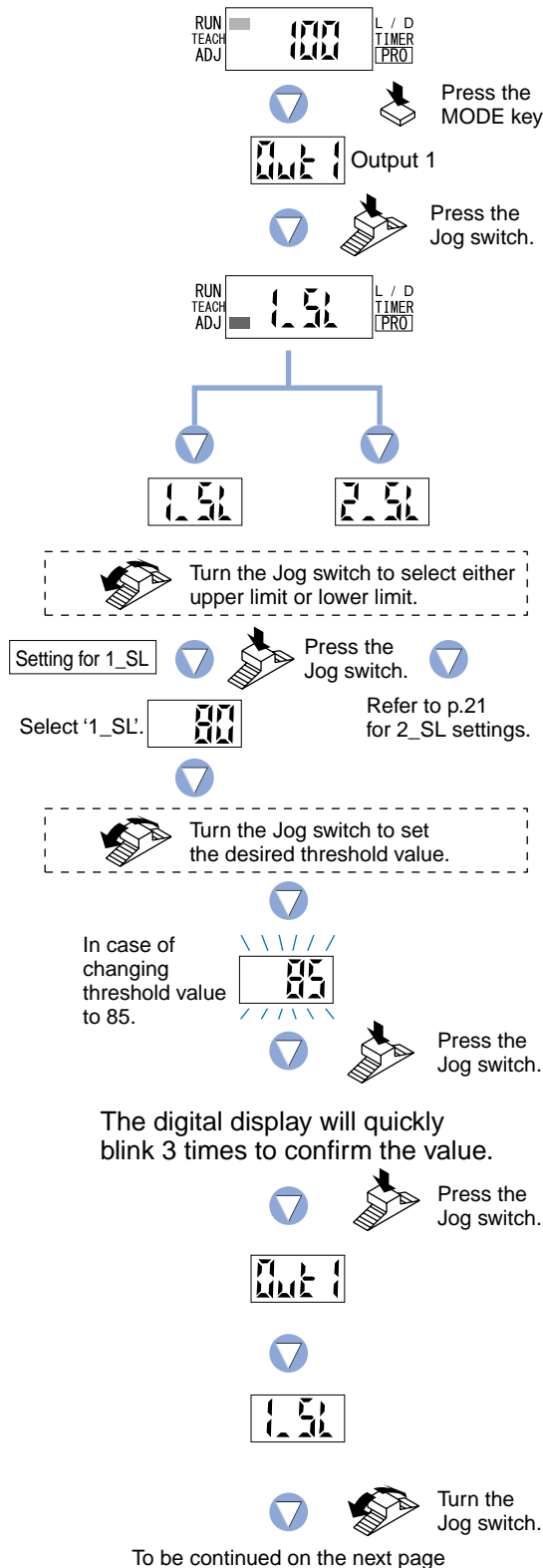

- ① Press the [MODE key] twice to select 'threshold value fine adjustment mode'.
- ② Turn the [Jog switch] to set 'output 1'.
- ③ Press the [Jog switch] to select 'output 1'.
- ④ The lower limit setting '1.5' or the upper limit setting '2.5' will be displayed.
- ⑤ Turn the [Jog switch] to select '1_SL'. If the [Jog switch] is pressed, the threshold value for '1_SL' will be displayed. If an increased 'threshold value' is desired, turn the [Jog switch] toward the '+' direction. If a decreased 'threshold value' is desired, turn the [Jog switch] toward the '-' direction.
- ⑥ If the [Jog switch] is pressed, the display will blink quickly 3 times and the threshold value for '1_SL' will be confirmed.
- ⑦ '1.5' is displayed. If the [Jog switch] is turned, then the upper limit setting '2.5' will be displayed.

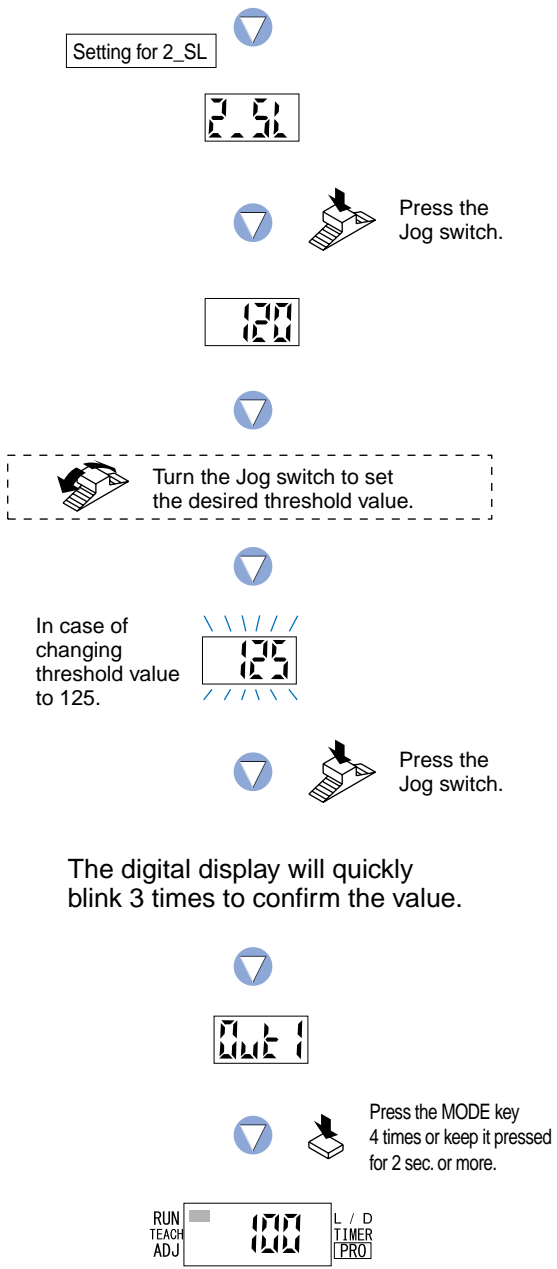

- ⑧ If the [Jog switch] is pressed, the threshold value for '2_SL' will be displayed. If an increased 'threshold value' is desired, turn the [Jog switch] toward the '+' direction. If a decreased 'threshold value' is desired, turn the [Jog switch] toward the '-' direction.
- ⑨ If the [Jog switch] is pressed, the display will blink quickly 3 times and the threshold value for '2_SL' will be confirmed.
- ⑩ Press the [MODE key] 4 times or keep it pressed for 2 sec. or more, the amplifier will return to 'RUN mode' (normal sensing operation).

4-6. Output Operation Setting Mode

This mode allows the selection of output operation from either L-ON (Light-ON) or D-ON (Dark-ON).

Output operation

FX-301(P)(-HS) or FX-305(P) normal mode

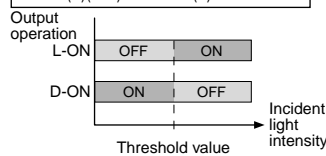

FX-305(P) window comparator mode

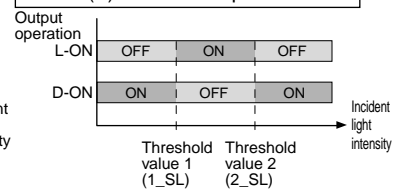

When setting rising differential mode for **FX-305(P)**

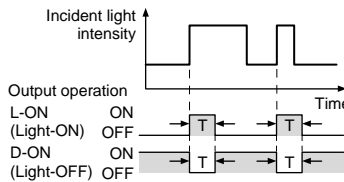

When setting trailing differential mode for **FX-305(P)**

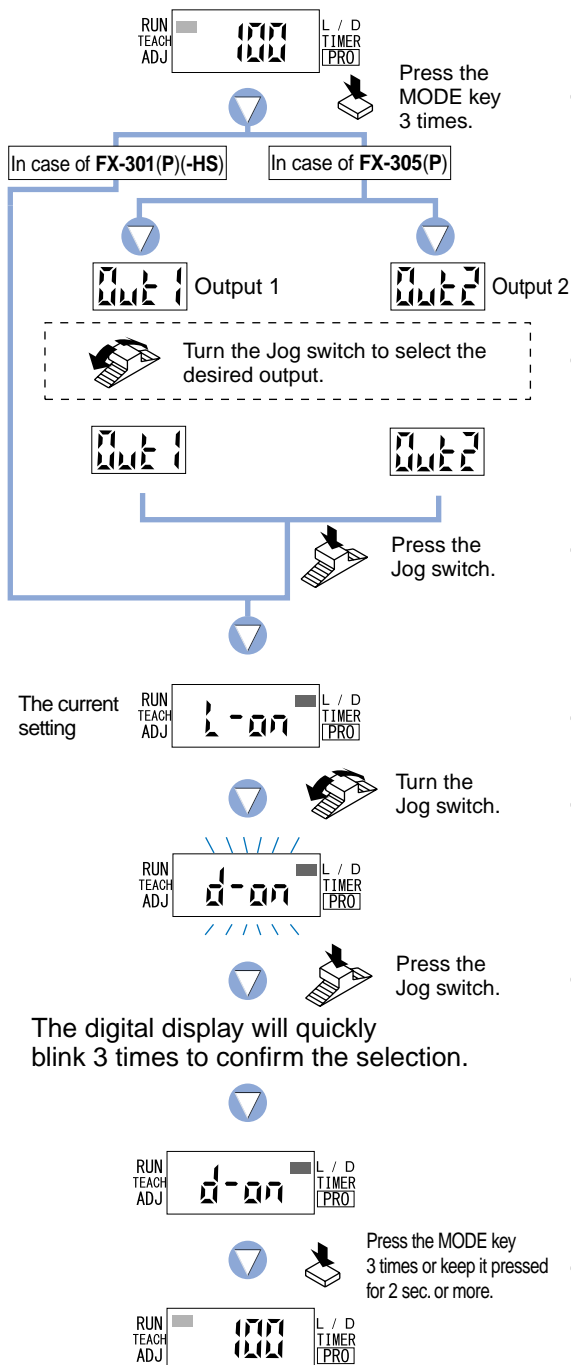
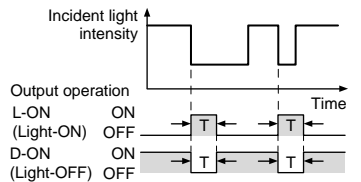

- ① Press the [MODE key] 3 times to select 'output operation setting mode'.
- ② **FX-305(P)**: Turn the [Jog switch] to select the desired 'output' for setting.
- ③ If the [Jog switch] is pressed, the 'output' will be confirmed.
- ④ The current setting will be displayed.
* The factory setting is 'L-ON (Light-ON)'.
- ⑤ If the [Jog switch] is turned, the opposite setting for output operation will blink on the display.
- ⑥ If the [Jog switch] is pressed, the digital display will blink quickly 3 times and the selected output operation will be confirmed.
- ⑦ Press the [MODE key] 3 times or keep it pressed for 2 sec. or more, the amplifier will return to 'RUN mode' (normal sensing operation).

4-7. Timer Operation Setting Mode

This mode sets the timer operation. Timer period is set in PRO1 mode.
The factory settings is 'Without timer'.

FX-301(P)(-HS)

This mode allows the configuration and usage of the following timer operations: OFF-delay / ON-delay / ONE SHOT.
Timer period can be selected from 0.5 ms to 9,999 ms.
Please refer to '5-3. Timer Setting Function [FX-301(P)(-HS)]' in 'PRO1 Mode' on p.28.

FX-305(P)

This mode allows the configuration and usage of the following timer operations: OFF-delay / ON-delay / ONE SHOT / ON-delay • OFF-delay / ON-delay • ONE SHOT.
Timer period can be selected from; Output 1: 0.5 ms to 9,999 ms, Output 2: 0.5 ms to 500 ms.
Please refer to '5-4. Timer Setting Function [FX-305(P)]' in 'PRO1 Mode' on p.29.

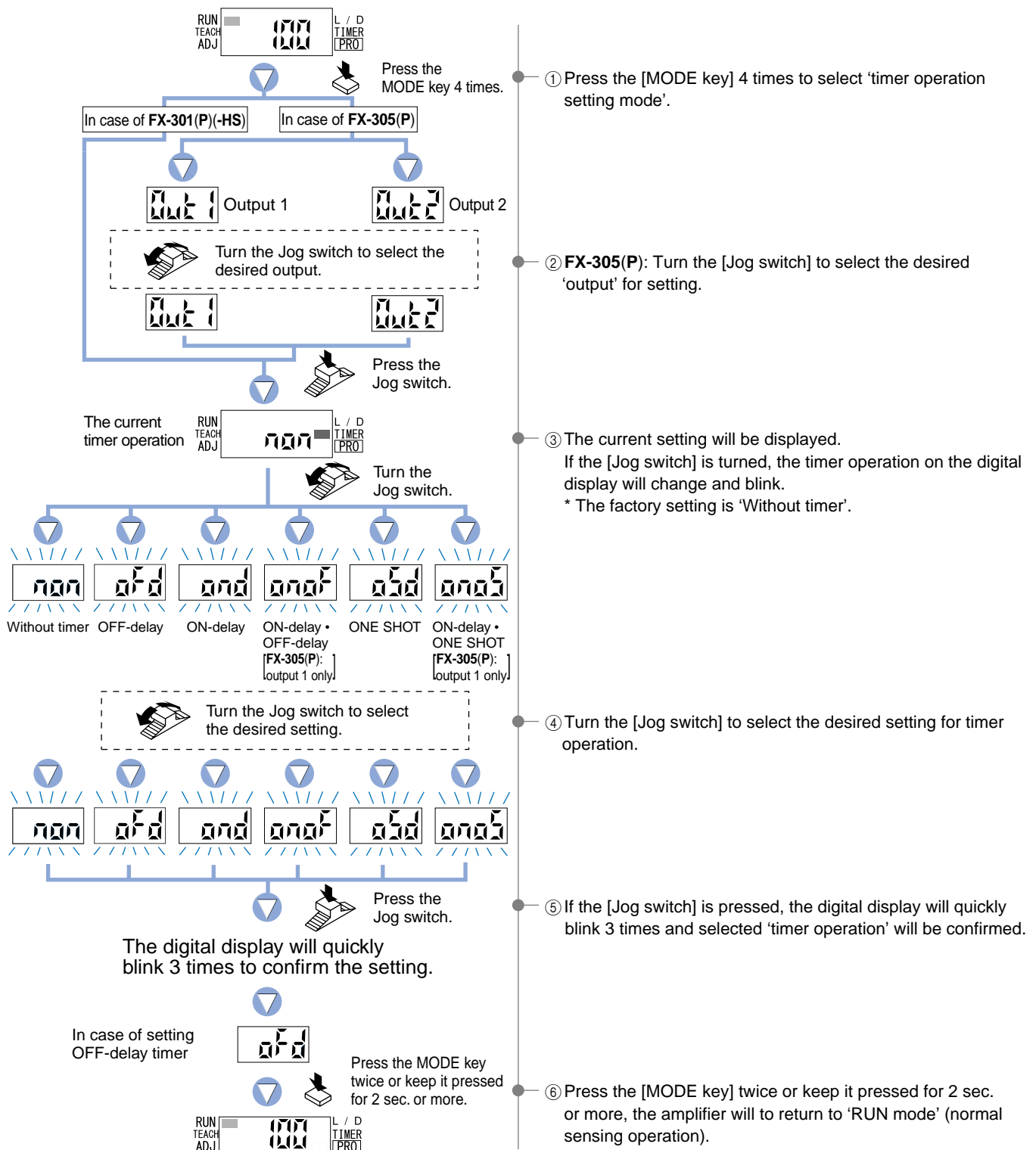

5 PRO1 Mode

5-1. PRO1 Mode Functions and Settings

PRO1 mode is used mainly for configuring the details of basic settings.

Response Time Change Function

Refer to p.27 for setting procedure

The response times for the **FX-301(P)(-HS)** can be switched among five levels: H-SP (ultra high-speed), FAST (high-speed), S-D (reduced intensity), STD (standard) and LONG (long-range). The **FX-305(P)** can be switched among six levels: the same as above without the S-D (reduced intensity) level but with STDF (standard 2) and U-LG (ultra long-range) levels. (The switching of response times among these levels will cause corresponding changes to the sensing range.)

* **FX-301(P)(-HS)**: The factory setting is 'STD (standard)'.

FX-305(P): The factory setting is 'STDF (standard 2)'.

Mode	Model No.	Response time		
		FX-301(P)(-HS)	FX-301(P)	FX-305(P)(Note)
(ultra high-speed)		35 μ s	65 μ s	65 μ s
(high-speed)		150 μ s	150 μ s	150 μ s
(reduced intensity)		250 μ s	250 μ s	—
(standard)		250 μ s	250 μ s	250 μ s
(standard 2)		—	—	700 μ s
(long-range)		2 ms	2 ms	2.5 ms
(ultra long-range)		—	—	4.5 ms

Note: If the interference prevention function is set to , the response time will become doubled.

- * (Ultra high-speed) : when performing sensing of ultra high-speed objects
- (high-speed) : when performing sensing of high-speed objects
- (reduced intensity): suitable for when the received light is saturated due to too short a setting distance, and for delicate sensing when sensing translucent objects, etc.
- (standard) : standard setting
- (standard 2) : The incident light intensity for standard settings can be set to up to 9,999 [digit]
- (long-range) : when long sensing range is required
- (ultra long-range) : when a longer sensing range than for is required.

Timer Setting Function

Refer to p.28~ for setting procedure

FX-301(P)(-HS) P.28

Four different timer operations can be selected; Without timer / OFF-delay / ON-delay / ONE SHOT. The available timer periods are 0.5 ms and 1 to 9,999 ms.

* The settings allow timer operation to be switched among Without timer / OFF-delay / ON-delay / ONE SHOT timer when in 'NAVI mode'.

FX-305(P) P.29

For output 1, six different timer operations can be selected: Without timer / OFF-delay / ON-delay / ONE SHOT / ON-delay • OFF-delay / ON-delay • ONE SHOT.

For output 2, four different timer operations can be selected: Without timer / OFF-delay / ON-delay / ONE SHOT.

The range of available timer periods is;

Output 1: 0.5 ms, 1 to 9,999 ms

Output 2: 0.5 ms, 1 to 500 ms

* The settings allow timer operation to be switched among Without timer / OFF-delay / ON-delay / ONE SHOT / ON-delay • OFF-delay / ON-delay • ONE SHOT when in 'NAVI mode'.

Time chart (common to **FX-301(P)(-HS)/305(P)**); however, only the **FX-305(P)** is equipped with ON-delay / OFF-delay and ON-delay • ONE SHOT timers.

Timer operation	Sensing condition		Beam-received Beam-interrupted
	Output operation		
(Without timer)	L-ON		ON OFF
	D-ON		ON OFF
(ON-delay)	L-ON		ON OFF
	D-ON		ON OFF
(OFF-delay)	L-ON		ON OFF
	D-ON		ON OFF
(ONE SHOT)	L-ON		ON OFF
	D-ON		ON OFF
(ON-delay • OFF-delay)	L-ON		ON OFF
	D-ON		ON OFF
(ON-delay • ONE SHOT)	L-ON		ON OFF
	D-ON		ON OFF

Available timer periods are:

FX-301(P)(-HS) Timer period T₁, T₂ = 0.5 ms, 1 to 9,999 ms

FX-305(P) Timer period; output 1: T₁, T₂ = 0.5 ms, 1 to 9,999 ms
output 2: T₁, T₂ = 0.5 ms, 1 to 500 ms

	T ₁	T ₂
	ON-delay timer period	————
	OFF-delay timer period	————
	Pulse width of ONE SHOT	————
	ON-delay timer period	OFF-delay timer period
	ON-delay timer period	Pulse width of ONE SHOT

* OFF-delay : Extends the output signal for a fixed period of time.

This function is useful if the output signal is so short that the connected device cannot respond.

ON-delay : Neglects short output signals. As only long signals are extracted, this function is useful for detecting if a line is clogged, or for sensing only objects taking a long time to travel.

ONE SHOT: Outputs a fixed width signal upon sensing.

This function is useful when the input specifications of the connected device require a signal of fixed width.

ON-delay • OFF-delay : The ON-delay and the OFF-delay timer functions can operate simultaneously.

ON-delay • ONE SHOT: The ON-delay and the ONE SHOT timer functions can operate simultaneously.

Hysteresis Function

Refer to p.31 for setting procedure

Selects the hysteresis from among three different levels (small / standard / large).

* The factory setting is 'H-02 (standard)'.

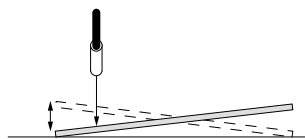

* H-01 (small) : The optimal limit of detection range

H-02 (standard) : Standard

H-03 (large) : Capability of detecting sensing objects having a vibratory motion

Stability Function

FX-301(P)(-HS) only

Refer to p.32 for setting procedure

Permits selection from among three different stability indicator response levels (margin width: ± 5 % / ± 10 % / ± 15 %), for changes in the range of incident light.

* The factory setting is 'S-02 (margin width: ± 10 %)'.

Range of incident light of stability indicator

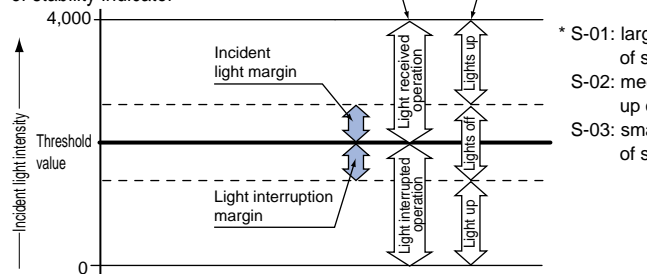

* S-01: large range for lighting up of stability indicator ± 5 %

S-02: medium range for lighting up of stability indicator ± 10 %

S-03: small range for lighting up of stability indicator ± 15 %

SFT : Shift Function

Refer to p.33 for setting procedure

Limit Teaching

Shifts the 'threshold value' by a certain percentage increment during 'limit teaching'.
 (The percentage adjustment is variable from 0 to 80 %, in increments of 5 %).
 * The factory setting is '15 %'.

When using reflective type fiber

If the threshold value is shifted toward the '-' direction, minute and severe detections become possible.

When using thru-beam type fiber

If the threshold value is shifted toward the '+' direction, minute and severe detections become possible.

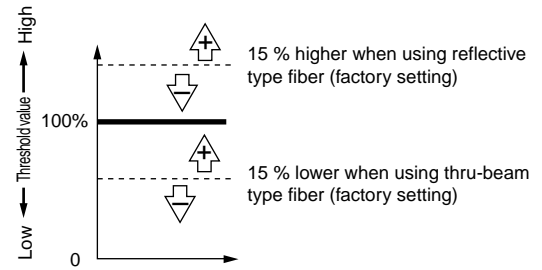

The threshold value is variable from 0 to 80 % (in increments of 5 %).

SEL : Light Emitting Amount Selection Function

Refer to p.34 for setting procedure

Changes the light emitting amount selection setting. The levels that can be selected will vary depending on the response time.

- **FX-301(P)** FAST, STD, LONG: 4-levels H-SP: 3-levels S-D: 2-levels
- **FX-301(P)-HS** FAST, STD, LONG: 4-levels H-SP, S-D: 2-levels
- **FX-305(P)** FAST, STD, STDF, LONG, U-LG: 4-levels H-SP: 3-levels

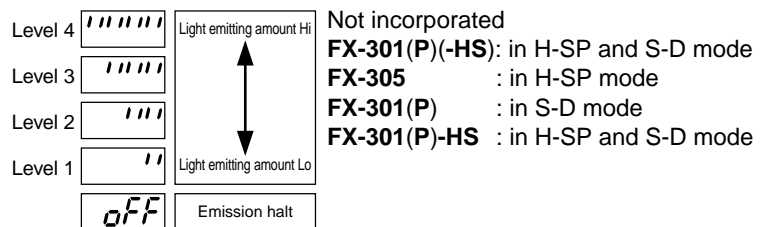

5-2. Response Time Change Function

For **FX-301(P)**(-HS), response time can be switched among five levels:

H-SP (ultra high-speed) / FAST (high-speed) / S-D (reduced intensity) / STD (standard) / LONG (long-range).

For **FX-305(P)**, response time can be switched among six levels:

H-SP (ultra high-speed) / FAST (high-speed) / STD (standard) / STDF (standard 2) / LONG (long-range) / U-LG (ultra long-range).

Model No.	Response time		
	FX-301(P)-HS	FX-301(P)	FX-305(P)(Note)
H-SP (ultra high-speed)	35 μ s	65 μ s	65 μ s
FAST (high-speed)	150 μ s	150 μ s	150 μ s
S-D (reduced intensity)	250 μ s	250 μ s	—
STD (standard)	250 μ s	250 μ s	250 μ s
STDF (standard 2)	—	—	700 μ s
LONG (long-range)	2 ms	2 ms	2.5 ms
U-LG (ultra long-range)	—	—	4.5 ms

Note: If the interference prevention function is set to 'P-2', the response time will become doubled.

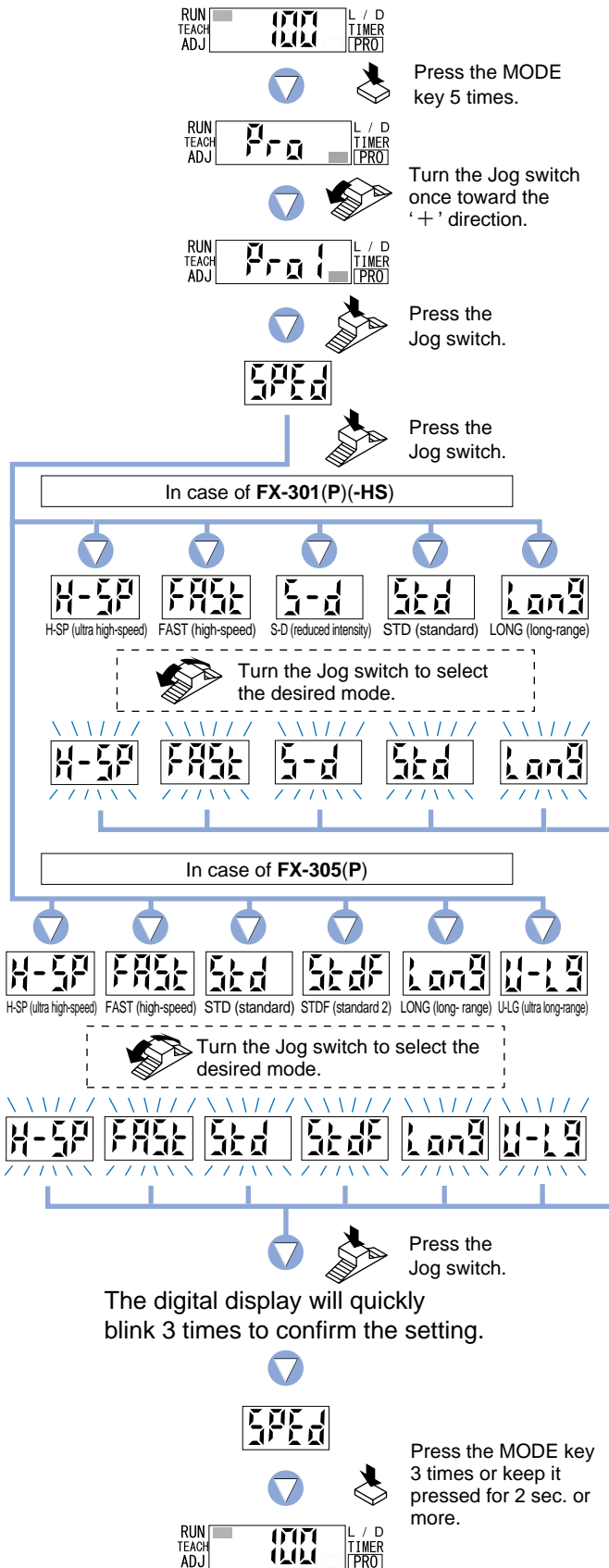

- ① Press the [MODE key] 5 times to select 'PRO mode'.
- ② Turn the [Jog switch] once toward the '+' direction, to select 'PRO1 mode'.
- ③ Press the [Jog switch] to enter the 'response time change' state.
- ④ If the [Jog switch] is pressed, the current mode will be displayed.
* **FX-301(P)**(-HS): The factory setting is 'STD (standard)'.
FX-305(P): The factory setting is 'STDF (standard 2)'.
- ⑤ If the [Jog switch] is turned, the digital display will blink. Select the desired response time.
- ⑥ If the [Jog switch] is pressed, the digital display will quickly blink 3 times, confirming the setting.
- ⑦ Press the [MODE key] 3 times or keep it pressed for 2 sec. or more, the amplifier will return to 'RUN mode' (normal sensing operation).

5-3. Timer Setting Function [FX-301(P)(-HS)]

Four different timer operations can be selected: Without timer / OFF-delay / ON-delay / ONE SHOT.
The available timer periods are 0.5 to 9,999 ms.

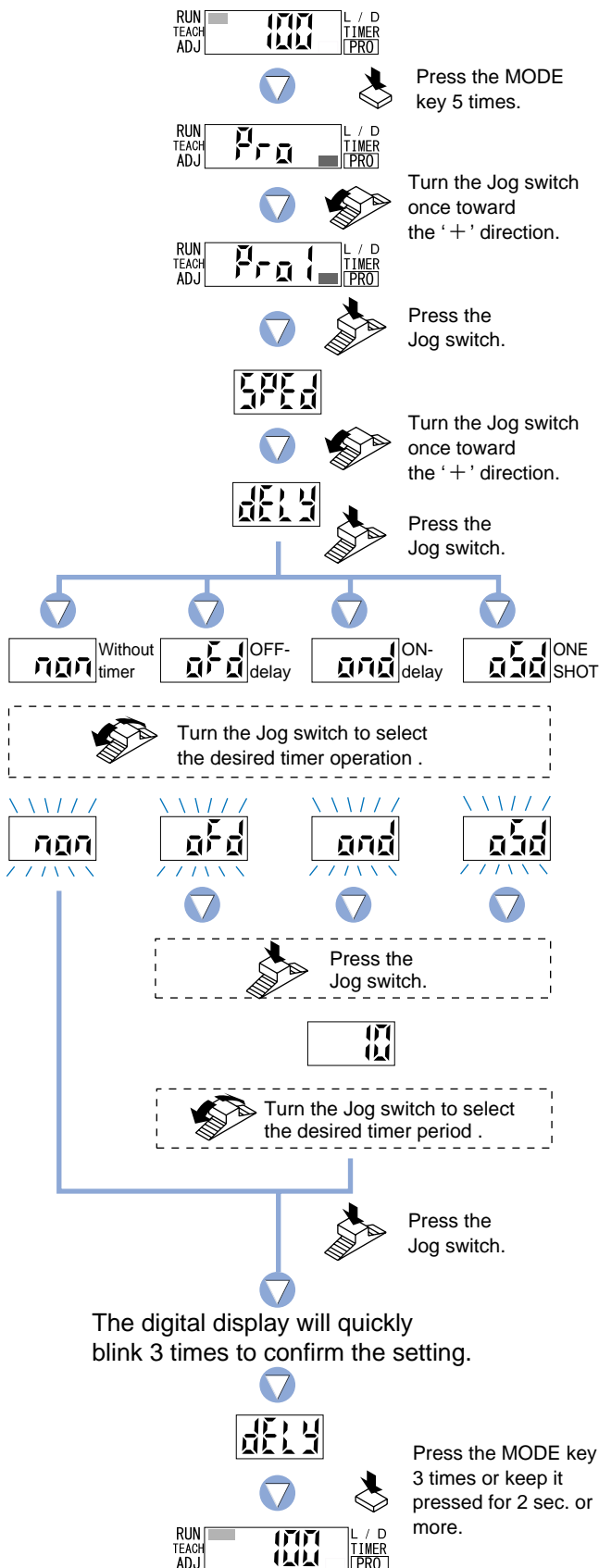

- ① Press the [MODE key] 5 times to select 'PRO mode'.
- ② Turn the [Jog switch] once toward the '+' direction, to select 'PRO1 mode'.
- ③ Press the [Jog switch] to enter the 'response time change' state.
- ④ Turn the [Jog switch] once toward the '+' direction, to enter the 'timer setting' state.
- ⑤ If the [Jog switch] is pressed, the current timer operation will be displayed.
* The factory setting is 'Without timer'.
- ⑥ If the [Jog switch] is turned, the digital display will blink. Select the desired timer operation.
* Timer selection is also possible in NAVI mode.
- ⑦ Press the [Jog switch] to enter the 'timer period setting' state.
* The factory setting is '10 ms'.
- ⑧ Turn the [Jog switch] to select the desired timer period.
* Timer period will be switched to the values set by timer operations, unless 'Without timer' is chosen.
- ⑨ If the [Jog switch] is pressed, the digital display will quickly blink 3 times, confirming the setting.
- ⑩ Press the [MODE key] 3 times or keep it pressed for 2 sec. or more, the amplifier will return to 'RUN mode' (normal sensing operation).

5-4. Timer Setting Function [FX-305(P)]

For output 1, six different timer operations can be selected: Without timer / OFF-delay / ON-delay / ONE SHOT / ON-delay • OFF-delay / ON-delay • ONE SHOT.

For output 2, four different timer operations can be selected: Without timer / OFF-delay / ON-delay / ONE SHOT.

Available timer periods are; Output 1: 0.5 to 9,999 ms,

Output 2: 0.5 to 500 ms

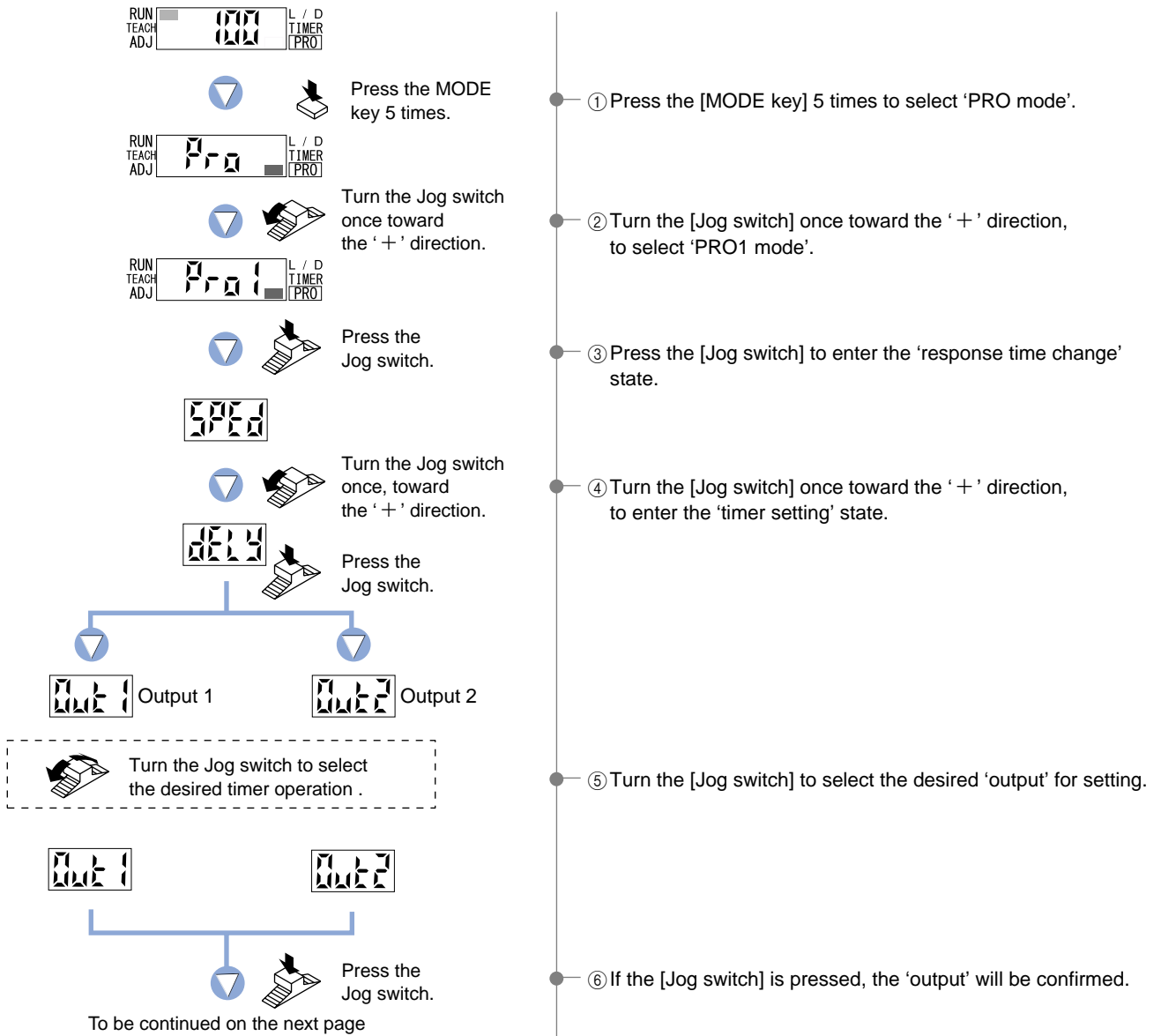

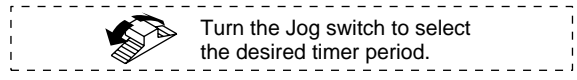
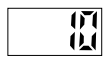
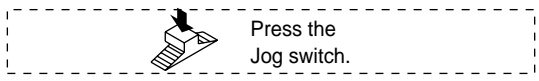
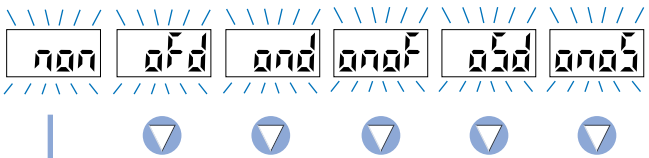
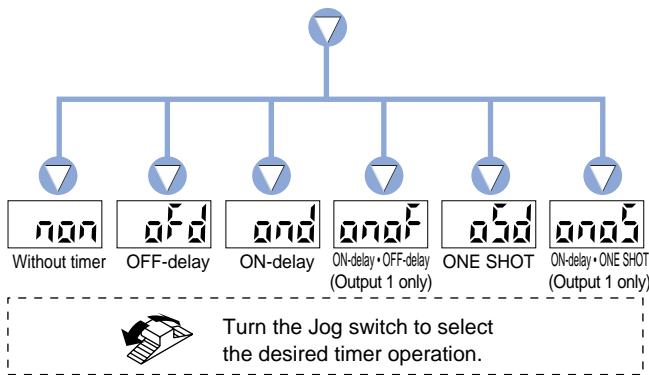

When using the ON-delay • OFF-delay timer combination or the ON-delay • ONE SHOT timer combination

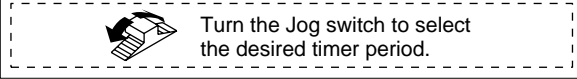
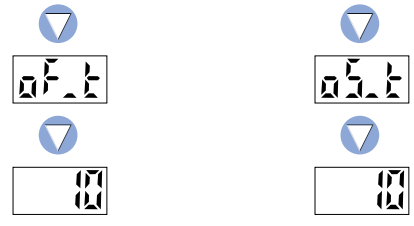
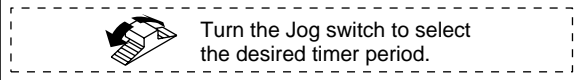
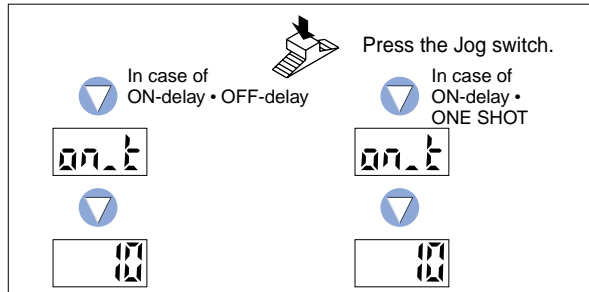

The digital display will quickly blink 3 times to confirm the setting.

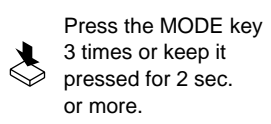
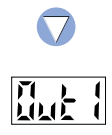

- ⑦ If the [Jog switch] is turned, the digital display will blink. Select the desired timer operation.
* Timer selection is also possible in 'NAVI mode'.
- ⑧ Press the [Jog switch] to enter the 'timer period setting' state.
* The factory setting is '10 ms'.
- ⑨ Turn the [Jog switch] to select the desired timer period. When using the ON-delay • OFF-delay timer combination or the ON-delay • ONE SHOT timer combination, each timer can be set individually.
* Timer period will be switched to the values set by timer operations, unless 'Without timer' is chosen.
- ⑩ Sets the timer period for the ON-delay timer.
- ⑪ Sets the OFF-delay timer period for ON-delay • OFF-delay timer settings, and the ONE SHOT timer period for ON-delay • ONE SHOT timer settings.
- ⑫ If the [Jog switch] is pressed, the digital display will quickly blink 3 times, confirming the setting.
- ⑬ The output that has been set will be displayed.
- ⑭ Press the [MODE key] 3 times or keep it pressed for 2 sec. or more, the amplifier will return to 'RUN mode' (normal sensing operation).

5-5. Hysteresis Function

This function selects the hysteresis from among three different levels (small / standard / large).

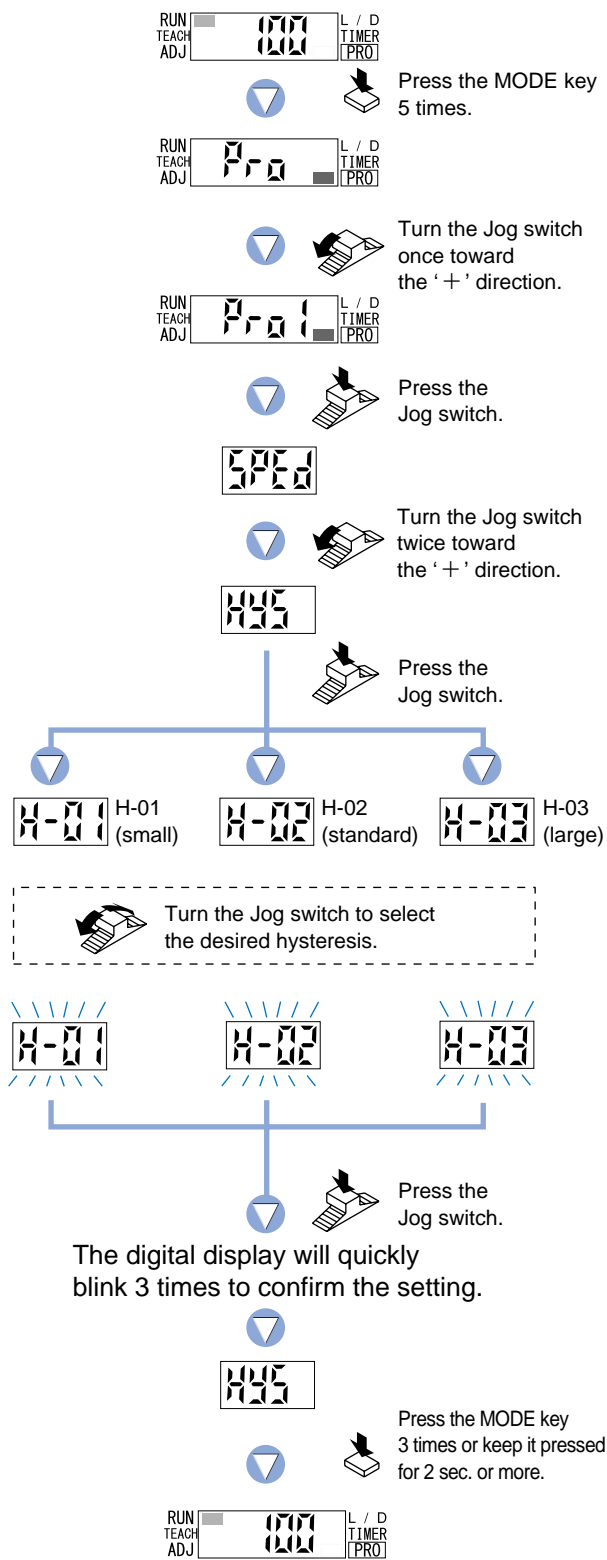

- ① Press the [MODE key] 5 times to select 'PRO mode'.
- ② Turn the [Jog switch] once toward the '+' direction, to select 'PRO1 mode'.
- ③ Press the [Jog switch] to enter the 'response time change' state.
- ④ Turn the [Jog switch] twice toward the '+' direction, to enter the 'hysteresis setting' state.
- ⑤ If the [Jog switch] is pressed, the current 'hysteresis' level will be displayed.
* The factory setting is 'H-02 (standard)'.
- ⑥ If the [Jog switch] is turned, the digital display will blink. Select the desired 'hysteresis' level.
- ⑦ If the [Jog switch] is pressed, the digital display will quickly blink 3 times, confirming the 'hysteresis' setting.
- ⑧ Press the [MODE key] 3 times or keep it pressed for 2 sec. or more, the amplifier will return to 'RUN mode' (normal sensing operation).

5-6. Stability Function [FX-301(P)(-HS) only]

This function permits selection among three different stability indicator response levels (margin width: $\pm 5\%$ / $\pm 10\%$ / $\pm 15\%$), for changes in the range of incident light.

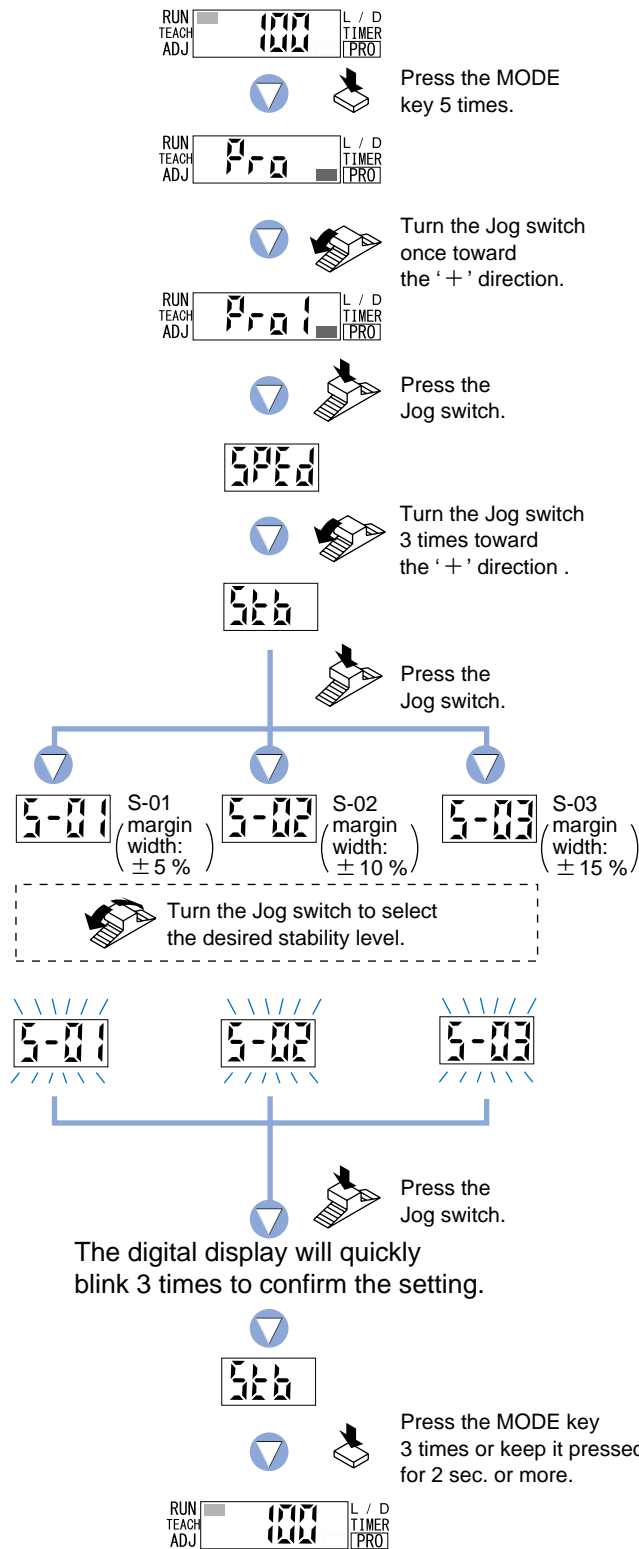

- ① Press the [MODE key] 5 times to select 'PRO mode'.
- ② Turn the [Jog switch] once toward the '+' direction, to select 'PRO1 mode'.
- ③ Press the [Jog switch] to enter the 'response time change' state.
- ④ Turn the [Jog switch] 3 times toward the '+' direction, to enter the 'stability setting' state.
- ⑤ If the [Jog switch] is pressed, the current setting for 'stability level' will be displayed.
* The factory setting is 'S-02 (margin width: $\pm 10\%$)'.
- ⑥ If the [Jog switch] is turned, the digital display will blink. Select the desired 'stability level'.
- ⑦ If the [Jog switch] is pressed, the digital display will quickly blink 3 times, confirming 'stability level' setting.
- ⑧ Press the [MODE key] 3 times or keep it pressed for 2 sec. or more, the amplifier will return to 'RUN mode' (normal sensing operation).

5-7. Shift Function

This function allows changing of the shift amount for the 'threshold value' during 'limit teaching'.
 (The percentage adjustment is variable from 0 to 80 %, in increments of 5 %.)

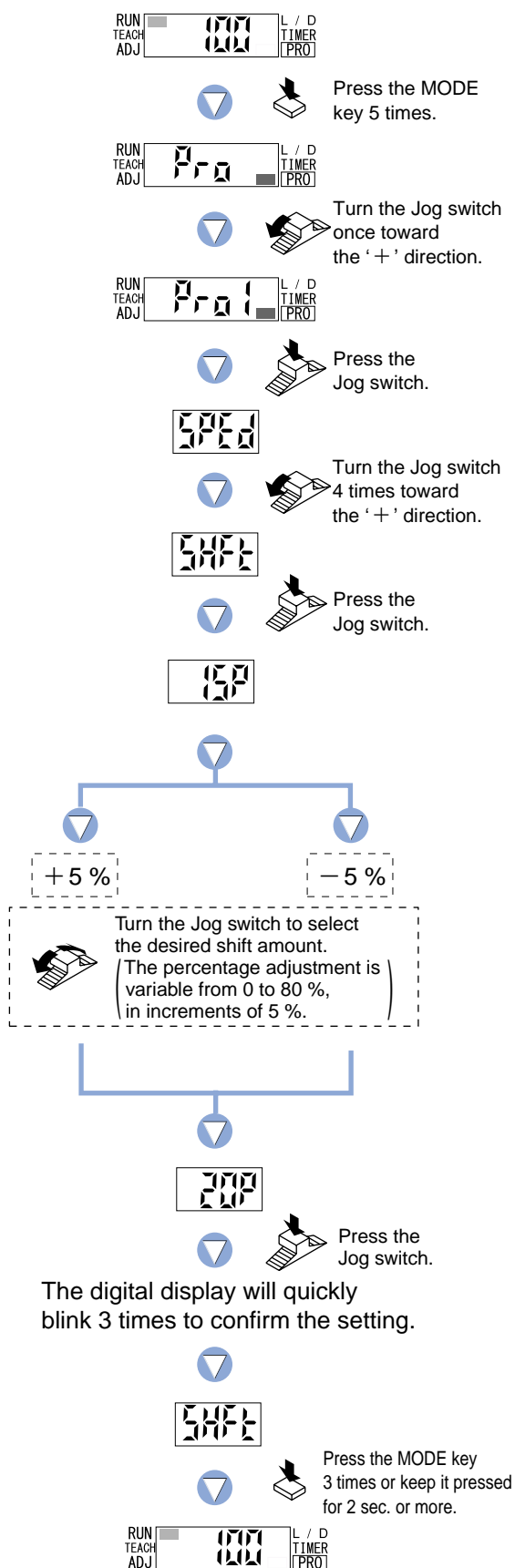

- ① Press the [MODE key] 5 times to select 'PRO mode'.
- ② Turn the [Jog switch] once toward the '+' direction, to select 'PRO1 mode'.
- ③ Press the [Jog switch] to enter the 'response time change' state.
- ④ Turn the [Jog switch] 4 times toward the '+' direction, to enter the 'shift setting' state.
- ⑤ If the [Jog switch] is pressed, the current 'shift amount' will be displayed.
- ⑥ If the [Jog switch] is turned, the digital display will blink. Select the desired 'shift amount'.
 (If the [Jog switch] is turned once toward the '+' direction, the shift amount will be + 5 %.
 If the [Jog switch] is turned once toward the '-' direction, the shift amount will be - 5 %.
 The available range for the shift amount:
 The percentage adjustment is variable from 0 to 80 %, in increments of 5 %.)
- ⑦ If the [Jog switch] is pressed, the digital display will quickly blink 3 times, confirming the 'shift amount' setting.
- ⑧ Press the [MODE key] 3 times or keep it pressed for 2 sec. or more, the amplifier will return to 'RUN mode' (normal sensing operation).

5-8. Light Emitting Amount Selection Function

This function allows changing of the light emitting amount. The levels that can be selected will vary depending on the response time.

- **FX-301(P)** FAST, STD, LONG: 4-levels H-SP: 3-levels S-D: 2-levels
- **FX-301(P)-HS** FAST, STD, LONG: 4-levels H-SP, S-D: 2-levels
- **FX-305(P)** FAST, STD, STDF, LONG, U-LG: 4-levels H-SP: 3-levels

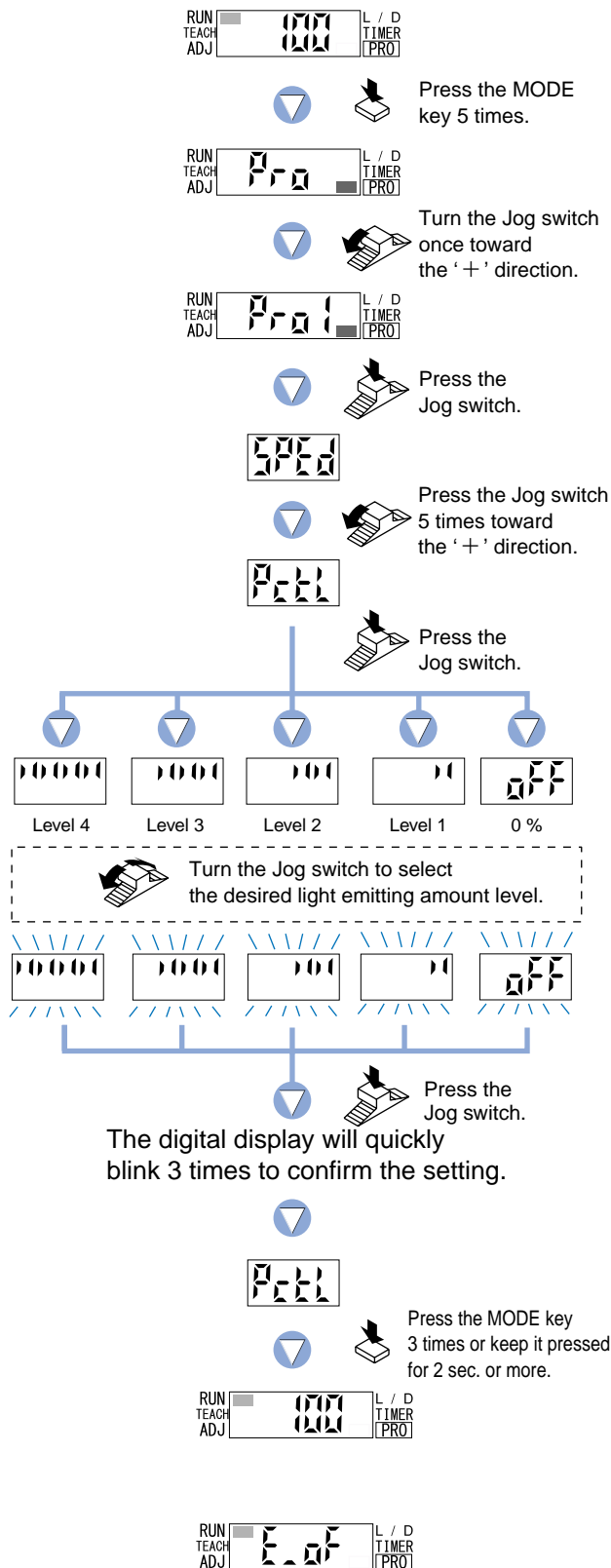

- ① Press the [MODE key] 5 times to select 'PRO mode'.
 - ② Turn the [Jog switch] once toward the '+' direction, to select 'PRO1 mode'.
 - ③ Press the [Jog switch] to enter the 'response time change' state.
 - ④ Turn the [Jog switch] 5 times to enter the 'light emitting amount level selection' state.
 - ⑤ If the [Jog switch] is pressed, the current 'light emitting amount level' will be displayed.
* **FX-301(P)**, **FX-305(P)**: The factory setting is 'level 4 (MAX.)'.
FX-301(P)-HS: The factory setting is 'level 2'.
 - ⑥ If the [Jog switch] is turned, the current 'light emitting amount level' will be displayed. Set to the desired 'light emitting amount level' from 'light emitting OFF' or between 'level 1' and 'level 4'.
* The levels that can be selected will vary depending on the response time.
• **FX-301(P)** FAST, STD, LONG: 4-levels H-SP: 3-levels S-D: 2-levels
• **FX-301(P)-HS** FAST, STD, LONG: 4-levels H-SP, S-D: 2-levels
• **FX-305(P)** FAST, STD, STDF, LONG, U-LG: 4-levels H-SP: 3-levels
 - ⑦ If the [Jog switch] is pressed, the digital display will quickly blink 3 times, confirming the 'light emitting amount level' setting.
 - ⑧ Press the [MODE key] 3 times or keep it pressed for 2 sec. or more, the amplifier will return to 'RUN mode' (normal sensing operation).
- * When the light emitting is set to OFF and the unit returns to RUN mode (normal sensing operation), 'OFF' will be displayed.

6 PRO2 Mode

6-1. PRO2 Mode Functions and Settings

PRO2 mode is used mainly for selecting the detailed configuration of the digital display.

Digital Display Setting Function

Refer to p.37 for setting procedure

This function allows the display to be switched among the different digital displays: [incident light intensity display / percentage display / peak hold display / bottom hold display / changed intensity display (Note)].

* The factory setting is 'incident light intensity display'.

Note: For **FX-305(P)**, when the differential mode 'd₊' or 'd₋' is set in PRO6 mode setting, the changed incident light intensity is displayed.

● Incident light intensity display

This function displays the incident light intensity within a range of 0 to 4,000.

[FX-305(P): 0 to 9,999 max.]



● Percentage display

This function displays the incident light intensity within a range of 1 P (1 %) to 999 P (999 %), based on the threshold value as a reference.



● Peak hold display

This function displays the peak numerical value of the incident light intensity.



Alternating display



● Bottom hold display

This function displays the bottom numerical value of the incident light intensity.



Alternating display



Display Timing for Peak Hold and Bottom Hold

Please note that the peak hold and bottom hold values will be refreshed consecutively.

Incident light intensity

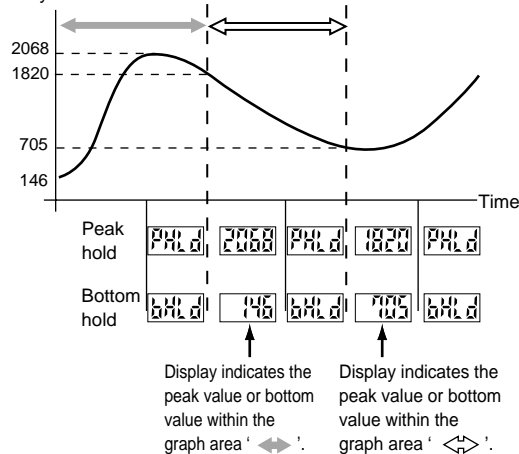

デジタル表示反転機能 :Digital Display Inversion Function

Refer to p.38 for setting procedure

This function can be used to invert the display orientation, according to the direction of amplifier installation.

* The factory setting is 'Turn OFF'.

- When set to 'Turn OFF'
- When set to 'Turn ON'



省電力モード設定機能 :ECO Mode Setting Function

Refer to p.39 for setting procedure

This function turns off the digital display to reduce current consumption.

If no operations are performed for 20 sec., the letters 'E C O' will blink and then the digital display will turn off.

If the [MODE key] or the [Jog switch] are operated, the digital display will light up again.

* The factory setting is 'ECO OFF'.

- When set to 'ECO OFF'
- When set to 'ECO ON'



Current Consumption

When ECO mode is OFF:

40 mA or less (at 24 V supply voltage)

When ECO mode is ON:

25 mA or less (at 24 V supply voltage)

6-2. Digital Display Setting Function

This function allows the display to be switched among the different digital displays (incident light intensity display, percentage display, peak hold display, bottom hold display, changed intensity display).

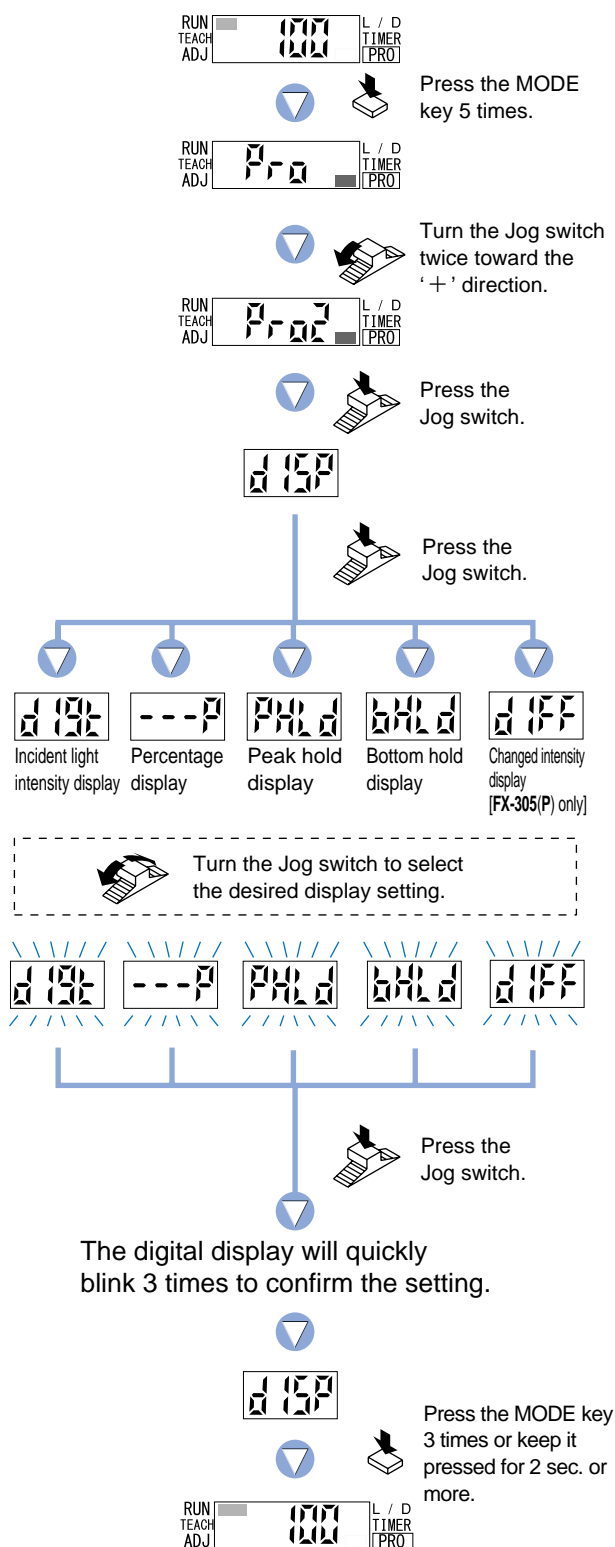

- ① Press the [MODE key] 5 times to select 'PRO mode'.
- ② Turn the [Jog switch] twice toward the '+' direction, to select 'PRO2 mode'.
- ③ Press the [Jog switch] to enter the 'digital display setting' state.
- ④ If the [Jog switch] is pressed, the current 'display setting' will be displayed.
* The factory setting is 'incident light intensity display'.
'd192' is only enabled when 'd11' or 'd12' differential mode is selected for the **FX-305(P)**.
- ⑤ If the [Jog switch] is turned, the digital display will blink. Select the desired 'display setting'. However, when the **FX-305(P)** is in window comparator mode, the percentage display function cannot be utilized.
- ⑥ If the [Jog switch] is pressed, the digital display will quickly blink 3 times and the 'display setting' will be confirmed.
- ⑦ Press the [MODE key] 3 times or keep it pressed for 2 sec. or more, the amplifier will return to 'RUN mode' (normal sensing operation).

6-3. Digital Display Inversion Function

This function can be used to invert the display orientation, according to the direction of amplifier installation.

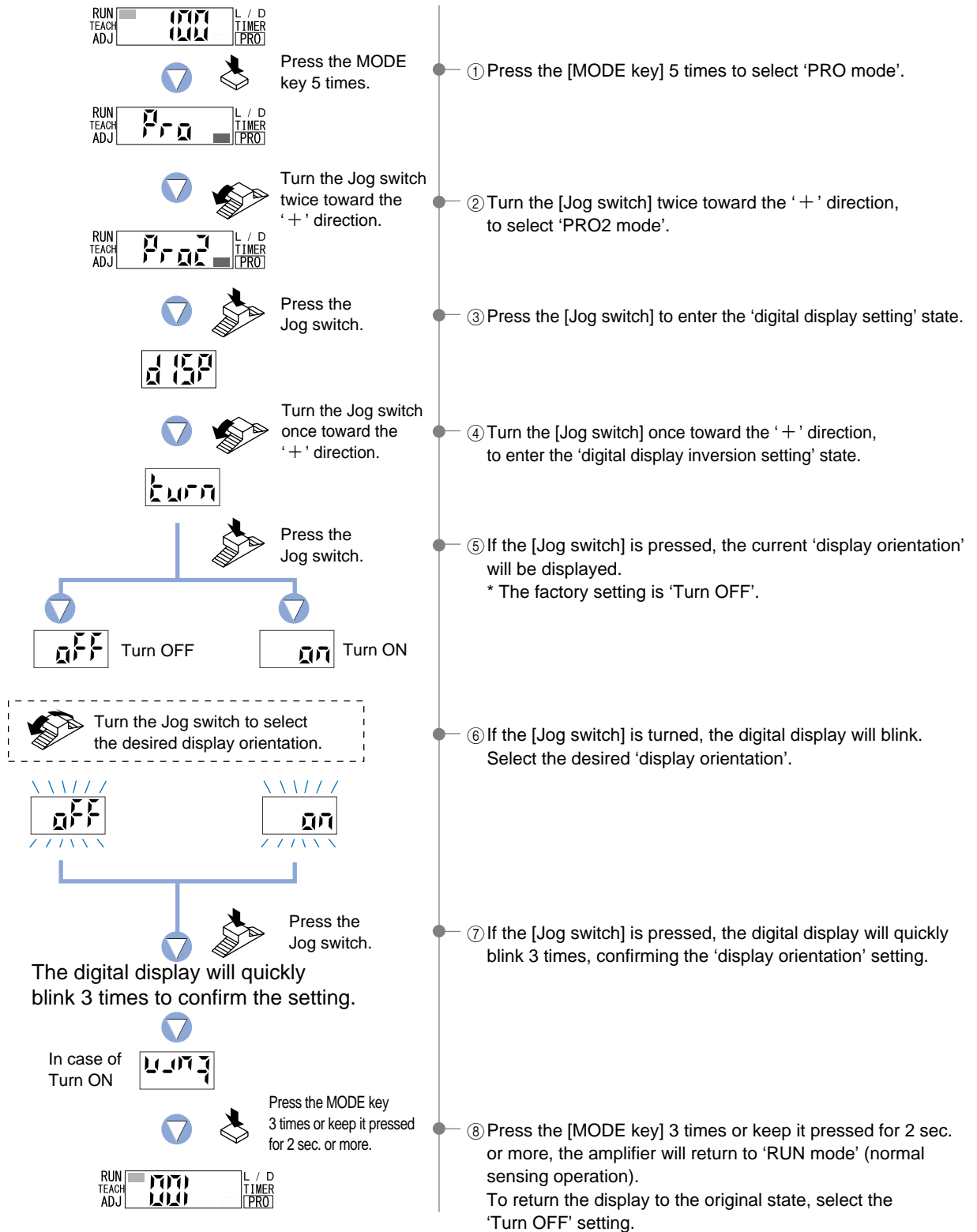

6-4. ECO Mode Setting Function

This function turns off the digital display to reduce current consumption.

If no operations are performed for 20 sec., the letters 'ECO' will blink and then the digital display will turn off.

If the [MODE key] or the [Jog switch] are operated, the digital display will light up again.

When set to ECO OFF



When set to ECO ON



Current Consumption

When ECO mode is OFF:

40 mA or less (at 24 V supply voltage)

When ECO mode is ON:

25 mA or less (at 24 V supply voltage)

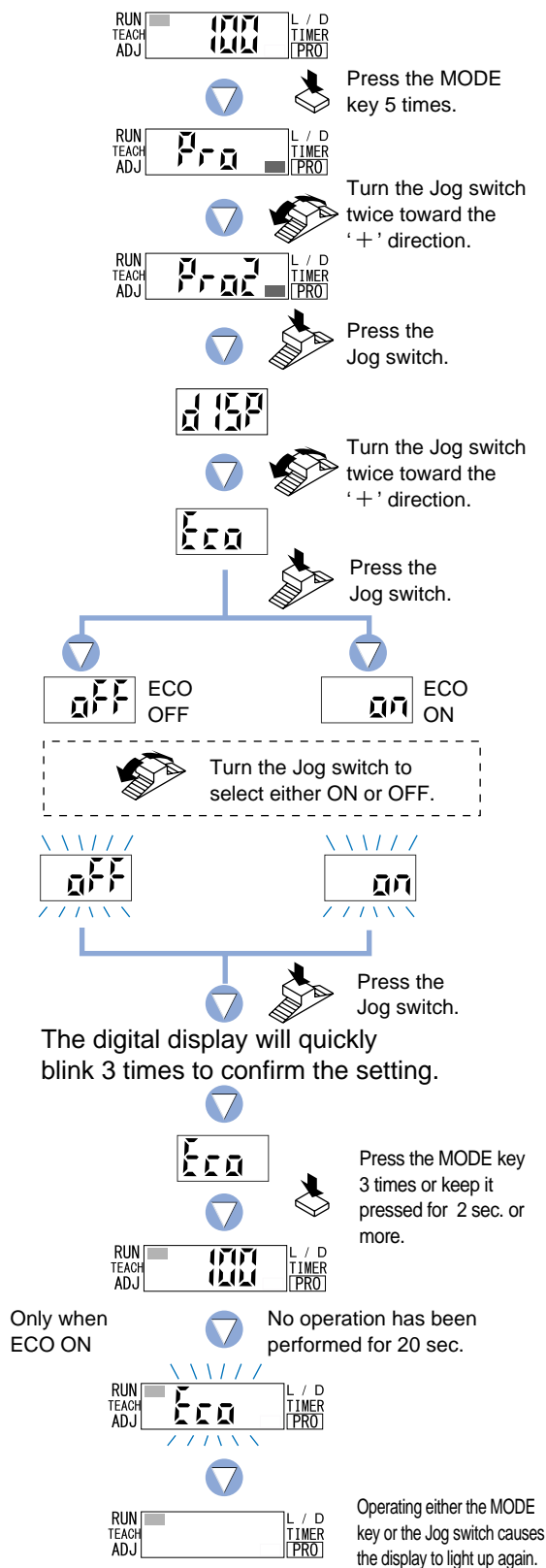

- ① Press the [MODE key] 5 times to select 'PRO mode'.
- ② Turn the [Jog switch] twice toward the '+' direction, to select 'PRO2 mode'.
- ③ Press the [Jog switch] to enter the 'digital display setting' state.
- ④ Turn the [Jog switch] twice toward the '+' direction, to enter the 'ECO mode setting' state.
- ⑤ If the [Jog switch] is pressed, the current setting will be displayed.
* The factory setting is 'ECO OFF'.
- ⑥ If the [Jog switch] is turned, the digital display will blink. Select from either 'ECO ON' or 'ECO OFF'.
- ⑦ If the [Jog switch] is pressed, the digital display will quickly blink 3 times, confirming the setting.
- ⑧ Press the [MODE key] 3 times or keep it pressed for 2 sec. or more, the amplifier will return to 'RUN mode' (normal sensing operation).
- ⑨ Only when the unit is set to ECO ON and no operations are performed for 20 sec., will the letters 'ECO' blink and the digital display then turn off.
- ⑩ If the [MODE key] or the [Jog switch] are operated, the digital display will light up again. To return the unit to the original state, select the setting 'ECO OFF'.

7 PRO3 Mode

7-1. PRO3 Mode Functions and Settings

PRO3 mode can load configuration settings from the data bank and can save configuration settings to the data bank.

Data bank

The **FX-301(P)(-HS)** and **FX-305(P)** incorporate an internal memory for storing configuration information. Three different sets of configuration settings can be stored within the data banks, in channels 1 (1st), 2 (2nd) to 3 (3rd). These configuration settings will not be deleted, unless they are intentionally overwritten by the data bank save setting function.

(Configuration information within the data bank will not be deleted, even when a reset is performed using the '9-4. Setting Reset Function' from 'PRO5 Mode' on p.53.)

:Data Bank Load Setting Function

Refer to p.41 for setting procedure

This function allows configuration settings information from the data bank to be selected and then loaded.

This feature allows settings to be changed quickly at times of reconfiguration, etc.

:Data Bank Save Setting Function

Refer to p.42 for setting procedure

This function saves amplifier configuration settings.

Up to 3 sets of configuration settings information can be saved in '1st', '2nd' and '3rd'.

7-2. Data Bank Load Setting Function

This function allows configuration settings information from the data bank to be selected and then loaded. This feature allows settings to be changed quickly at times of reconfiguration, etc.

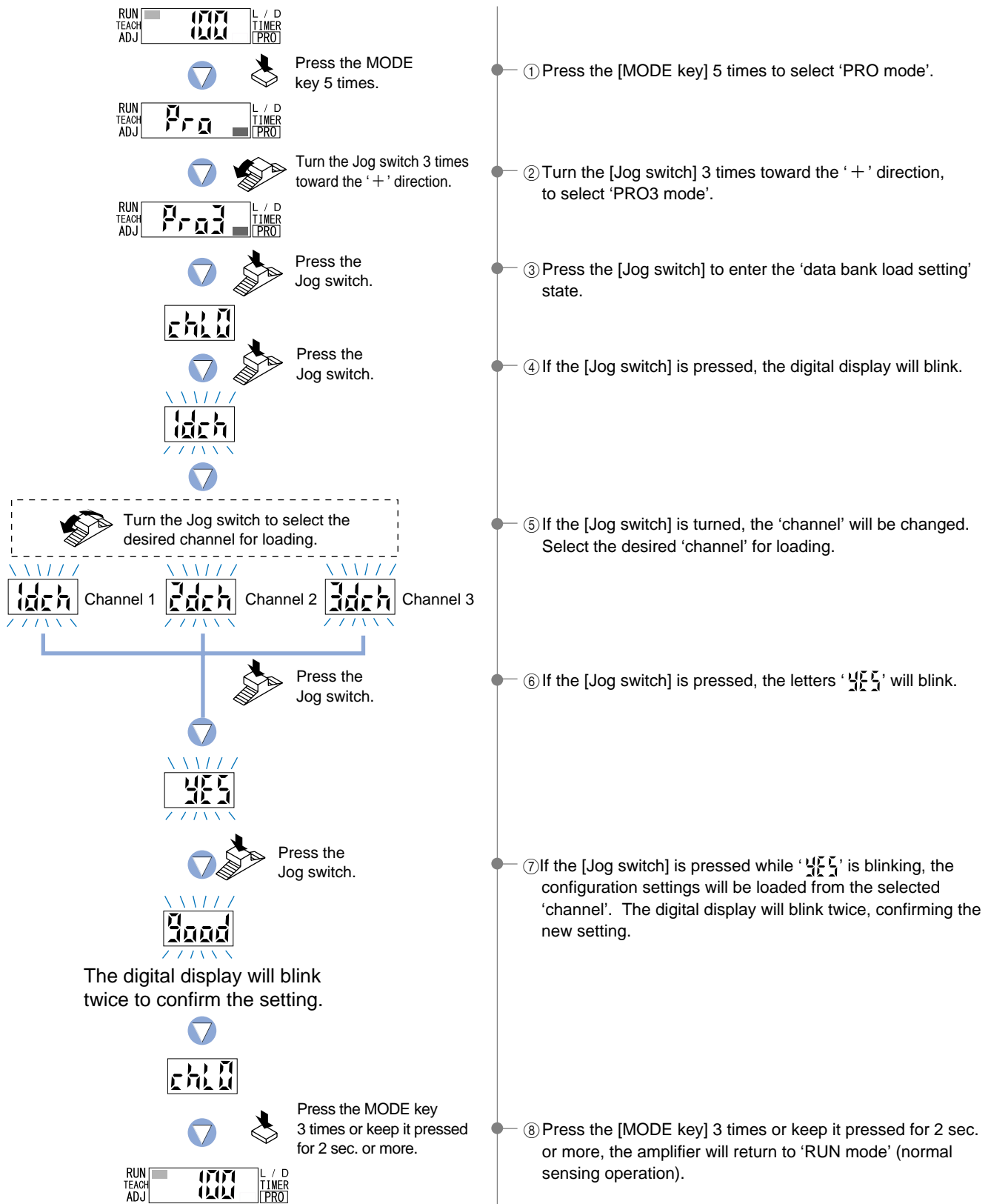

7-3. Data Bank Save Setting Function

This function saves amplifier configuration settings.

Up to 3 sets of configuration settings information can be saved in '1ch', '2ch' and '3ch'.

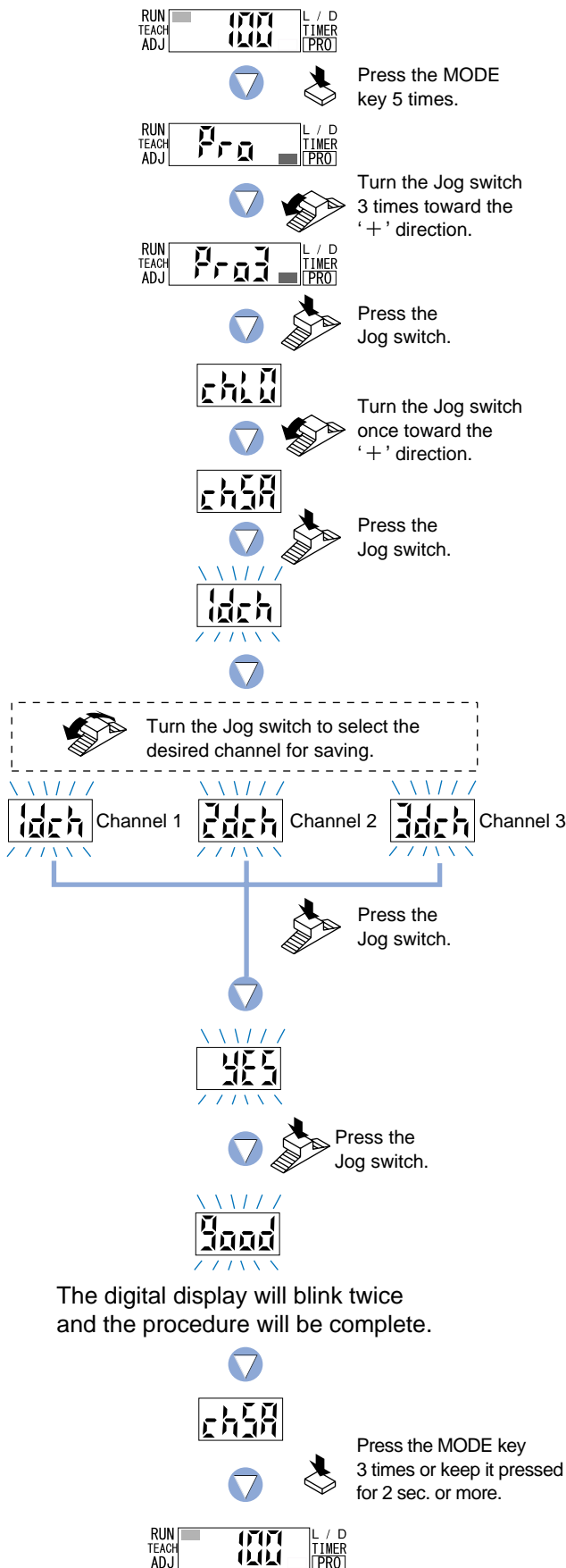

- ① Press the [MODE key] 5 times to select 'PRO mode'.
- ② Turn the [Jog switch] 3 times toward the '+' direction, to select 'PRO3 mode'.
- ③ Press the [Jog switch] to enter the 'data bank load setting' state.
- ④ Turn the [Jog switch] once toward the '+' direction, to enter the 'data bank save setting' state.
- ⑤ If the [Jog switch] is pressed, the digital display will blink.
- ⑥ If the [Jog switch] is turned, the 'channel' will be changed. Select the desired 'channel' for saving.
- ⑦ If the [Jog switch] is pressed, the letters 'YES' will blink.
- ⑧ If the [Jog switch] is pressed while 'YES' is blinking, the configuration settings will be saved to the selected 'channel'. The digital display will blink twice and the procedure will be complete.
- ⑨ Press the [MODE key] 3 times or keep it pressed for 2 sec. or more, the amplifier will return to 'RUN mode' (normal sensing operation).

8 PRO4 Mode

8-1. PRO4 Mode Functions and Settings

PRO4 mode is used mainly for configuring the communications with sub units.

* **FX-301(P)-HS** is not equipped with an optical communication function, so the PRO4 mode cannot be set.

The optical communications function

The **FX-301(P)** and **FX-305(P)** incorporate an optical communication function. By utilizing optical communications, interference can be prevented and configuration settings information can be copied among connected amplifiers. Optical communications can occur only in the direction shown in the diagram below. The maximum number of communicating units is 16, including the main unit.

Also, note that optical communication cannot be used when the line settings are being changed (when indicators are blinking) and when PRO mode is set. Be aware that sensing operations will not be possible when the optical communication feature is in use.

If using optical communication with the **FX-301(P)**(previous version unit) or **FX-301B/G/H(P)**(blue / green / infrared LED) together with the **FX-301(P)**(updated version unit) or **FX-305(P)**, optical communication may not work properly depending on the order of connection. Refer to 'Points to note when combining sensor types' (P.5) for further details.

Example: when 16 units are connected in the side-by-side configuration.

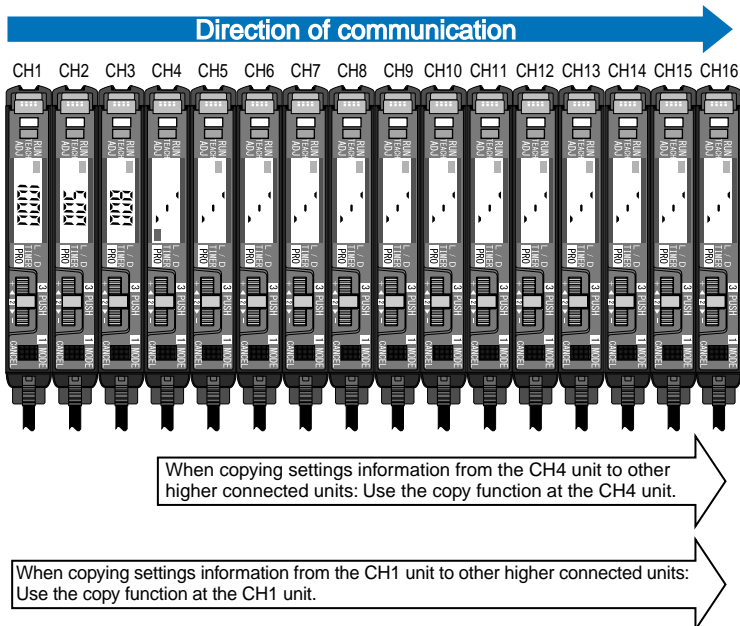

: Setting Condition Copy Function

Refer to p.64 for setting procedure

By utilizing the optical communications function, the settings information from the operating amplifier can be copied to other connected units. (Except for data bank contents) In addition, copying will not be carried out for **FX-301(P)** and **FX-305(P)** units in which the optical communication function has been locked.

Note) It is not possible to communicate setting information between **FX-301(P)**, **FX-301B/G/H(P)** and **FX-305(P)** units when using the setting condition copy function. Therefore, if units of different models need to be connected together, then units of the same model should be connected side-by-side.

: Remote Data Bank Load Setting Function

Refer to p.45 for setting procedure

By utilizing optical communication, settings within the data banks of each connected amplifier can be loaded all at once. However, channel data will not be loaded for **FX-301(P)** and **FX-305(P)** units in which the optical communication setting function has been locked. Setting information can be quickly changed during reconfiguration.

: Remote Data Bank Save Setting Function

Refer to p.46 for setting procedure

This function allows the current configuration setting information for all connected amplifiers to be saved into the respective data banks.

Saves on the labor required to store individual settings, one-by-one, for each amplifier. Up to 3 sets of configuration settings information can be saved for each amplifier. However, in **FX-301(P)** or **FX-305(P)** units in which the optical communications settings change function has been locked, information will not be saved.

: Selection for Communication Change to Permit / Not to Permit

Refer to p.47 for setting procedure

If the optical communication setting change function has been locked when attempting to carry out copy / load / save operations on all amplifiers at once using the setting condition copy function, remote data bank setting function or remote data bank save setting function while in PRO mode, only the amplifier being configured will be locked. As a result, copy / load / save operations can be carried out on except the locked units.

* The factory setting is 'Lock OFF'.

: Backup Setting Function

Refer to p.48 for setting procedure

This function does not store the threshold values in the EEPROM when teaching via external input. Prevents frequent overwriting of data in the EEPROM.

* Note that when the power is turned off, the threshold values will become the values that were last stored in memory.

8-2. Setting Contents Copy Function [Except FX-301(P)-HS]

By utilizing the optical communications function, the settings information from the operating amplifier can be copied to other connected units. (Except for data bank contents) In addition, copying will not be carried out for **FX-301(P)** and **FX-305(P)** units in which the optical communication function has been locked.

Note) It is not possible to communicate setting information between **FX-301(P)**, **FX-301B/G/H(P)** and **FX-305(P)** units using the setting condition copy function. Therefore, if units of different models need to be connected together, then units of the same model should be connected side-by-side.

Please refer to p.43 [The optical communications function](#) for the direction of optical communication.

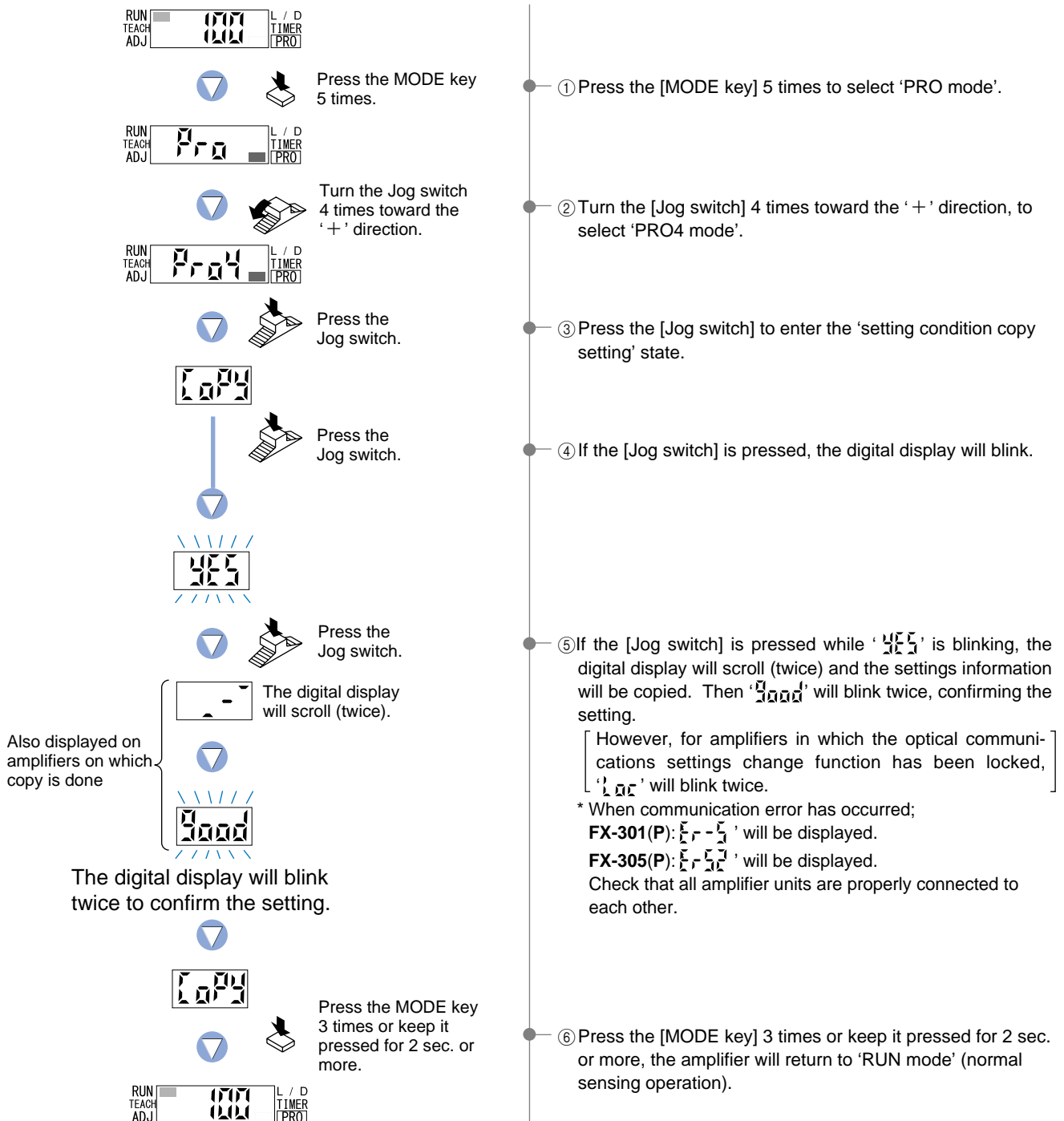

8-3. Remote Data Bank Load Setting Function [Except FX-301(P)-HS]

By utilizing optical communication, settings within the data banks of each connected amplifier can be loaded all at once. However, channel data will not be loaded for **FX-301(P)** and **FX-305(P)** units in which the optical communication setting function has been locked.

Please refer to p.43 **The optical communications function** for the direction of optical communication.

① Press the [MODE key] 5 times to select 'PRO mode'.

② Turn the [Jog switch] 4 times toward the '+' direction, to select 'PRO4 mode'.

③ Press the [Jog switch] to enter the 'setting condition copy setting' state.

④ Turn the [Jog switch] once toward the '+' direction, to enter the 'remote data bank load setting' state.

⑤ If the [Jog switch] is pressed, the digital display will blink.

⑥ Turn the [Jog switch] to select the desired 'channel' for loading for all amplifiers at once.

⑦ If the [Jog switch] is pressed, the letters '4E5' will blink.

⑧ If the [Jog switch] is pressed while '4E5' is blinking, the digital display will scroll (twice) and the settings information will be loaded for all amplifiers at once. Then 'CH1' will blink twice, confirming the setting.
 [However, for amplifiers **FX-301(P)** or **FX-305(P)** in which the optical communications settings change function has been locked, 'L D' will blink twice.]

⑨ Press the [MODE key] 3 times or keep it pressed for 2 sec. or more, the amplifier will return to 'RUN mode' (normal sensing operation).

Displayed on amplifiers on which communication is being done.

The digital display will blink twice to confirm the setting.

8-4. Remote Data Bank Save Setting Function [Except FX-301(P)-HS]

This function allows the current configuration setting information for all connected amplifiers to be saved into the respective data banks. Up to 3 sets of configuration settings information can be saved into each amplifier, using '1dch', '2dch' and '3dch'. However, units in which the optical communications settings change function has been locked, saving will not occur. Please refer to p.43 [The optical communications function](#) for the direction of optical communication.

① Press the [MODE key] 5 times to select 'PRO mode'.

② Turn the [Jog switch] 4 times toward the '+' direction, to select 'PRO4 mode'.

③ Press the [Jog switch] to enter the 'setting condition copy setting' state.

④ Turn the [Jog switch] twice toward the '+' direction, to enter the 'remote data bank save setting' state.

⑤ If the [Jog switch] is pressed, the digital display will blink.

⑥ Turn the [Jog switch] to select the desired 'channel' for saving for all amplifiers at once.

⑦ If the [Jog switch] is pressed, the letters 'YES' will blink.

⑧ If the [Jog switch] is pressed while 'YES' is blinking, the digital display will scroll (twice) and the settings information will be saved for all amplifiers at once. Then '1dch' will blink twice and the procedure will be complete. [However, for amplifiers in which the optical communications settings change function has been locked, '1dch' will blink twice.]

⑨ Press the [MODE key] 3 times or keep it pressed for 2 sec. or more, the amplifier will return to 'RUN mode' (normal sensing operation).

Turn the Jog switch to select the desired channel for saving for all amplifiers at once.

Channel 1 Channel 2 Channel 3

Press the Jog switch.

Press the Jog switch.

Press the Jog switch.

Press the MODE key 3 times or keep it pressed for 2 sec. or more.

Displayed on amplifiers on which communication is being done.

The digital display will scroll (twice).

The digital display will blink twice and the procedure will be complete.

8-5. Selection for Communication Change to Permit / Not to Permit

If the optical communication setting change function has been locked when attempting to carry out copy / load / save operations on all amplifiers at once using the setting condition copy function, remote data bank setting function or remote data bank save setting function while in PRO mode, only the amplifier being configured will be locked. As a result, copy / load / save operations can be carried out except the locked units.

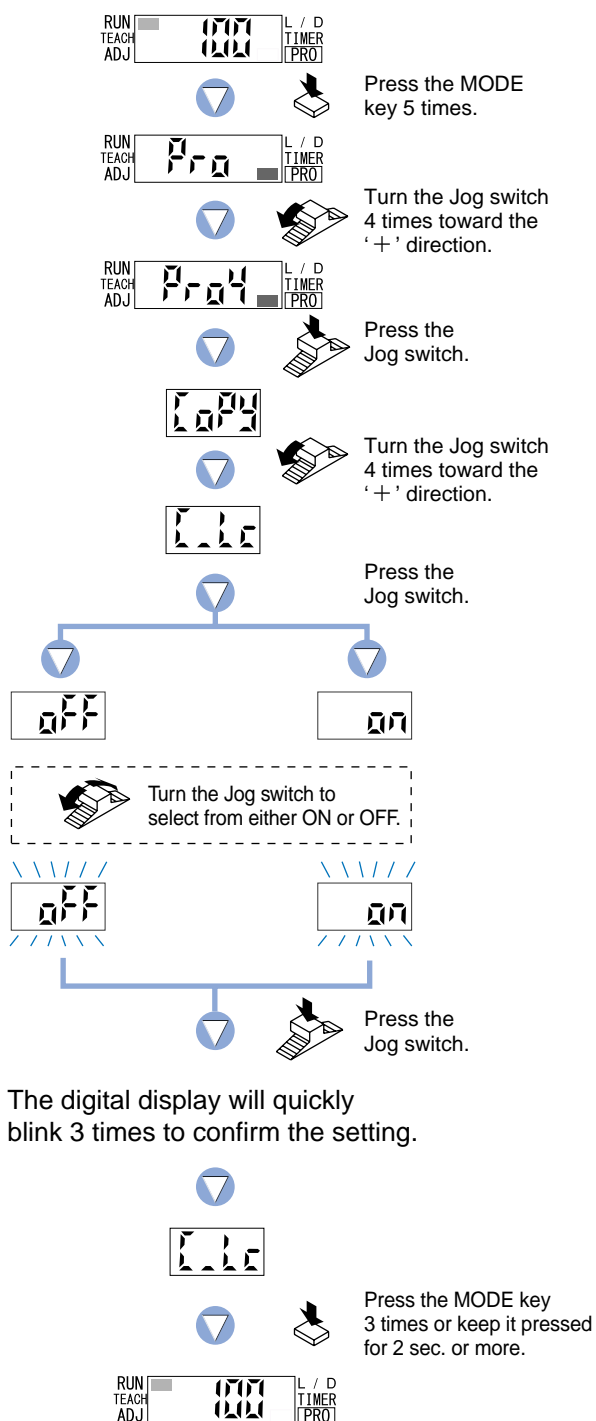

- ① Press the [MODE key] 5 times to select 'PRO mode'.
- ② Turn the [Jog switch] 4 times toward the '+' direction, to select 'PRO4 mode'.
- ③ Press the [Jog switch] to enter the 'setting condition copy setting' state.
- ④ Turn the [Jog switch] 4 times toward the '+' direction, to enter the 'selection for communication change to permit / not to permit'.
- ⑤ If the [Jog switch] is pressed, the current setting will be displayed.
* The factory setting is 'Lock OFF'.
- ⑥ If the [Jog switch] is turned, the digital display will blink. Select from either 'ON' or 'OFF'.
- ⑦ If the [Jog switch] is pressed, the digital display will quickly blink 3 times, confirming the setting.
- ⑧ Press the [MODE key] 3 times or keep it pressed for 2 sec. or more, the amplifier will return to 'RUN mode' (normal sensing operation).

8-6. Backup Setting Function

When using units such as the **FX-CH2**, this function does not store the threshold values in the EEPROM when teaching via external input. This prevents frequent overwriting of data in the EEPROM.

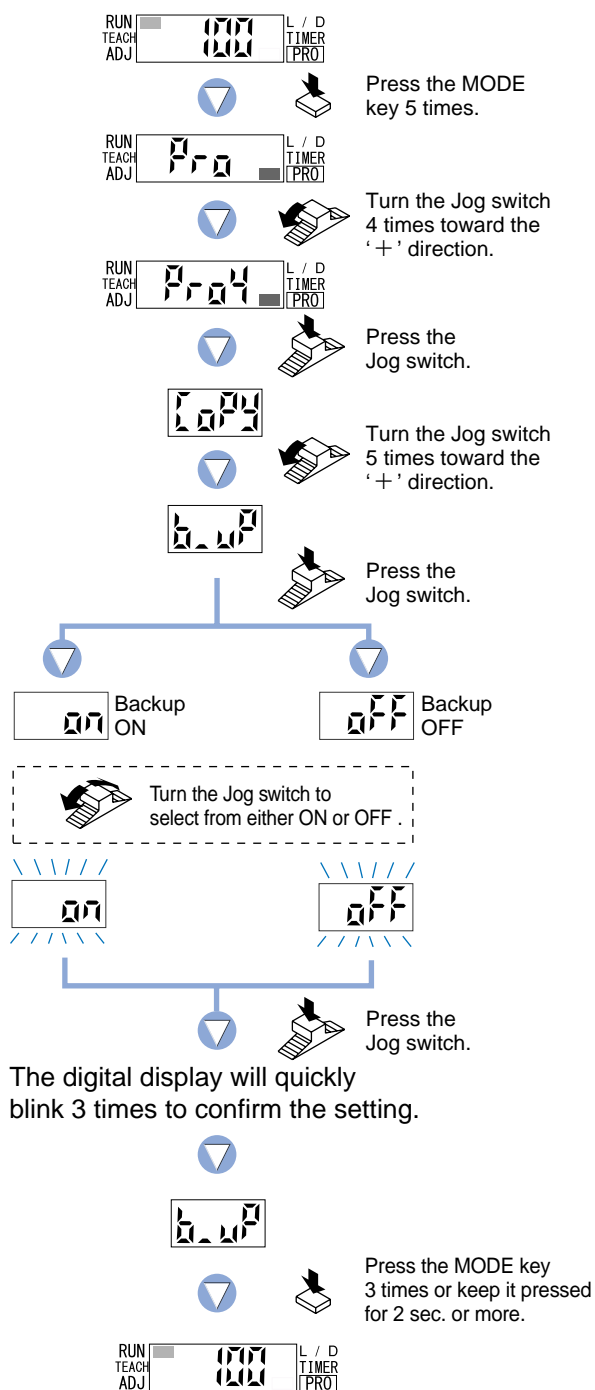

- ① Press the [MODE key] 5 times to select 'PRO mode'.
- ② Turn the [Jog switch] 4 times toward the '+' direction, to select 'PRO4 mode'.
- ③ Press the [Jog switch] to enter the 'setting condition copy setting' state.
- ④ Turn the [Jog switch] 5 times toward the '+' direction, to enter the 'backup ON / OFF setting' state.
- ⑤ If the [Jog switch] is pressed, the current setting will be displayed.
* The factory setting is 'Backup ON'.
- ⑥ If the [Jog switch] is turned, the digital display will blink. Select from either 'Backup ON' or 'Backup OFF'.
- ⑦ If the [Jog switch] is pressed, the digital display will quickly blink 3 times, confirming the setting.
- ⑧ Press the [MODE key] 3 times or keep it pressed for 2 sec. or more, the amplifier will return to 'RUN mode' (normal sensing operation).

9 PRO5 Mode

9-1. PRO5 Mode Functions and Settings

PRO5 mode allows the input of direct codes and adjust lock functions. It also permits the unit to be reset (re-initialized). Furthermore, the interference prevention function can be set for **FX-305(P)**.

Direct Code

FX-301(P)(-HS) and **FX-305(P)** contain certain encoded basic configuration information that can be set by inputting a 4-digit code. The functions that may be set using direct coding are: Response time, Hysteresis, L-ON / D-ON, Display setting, Adjust lock setting function, Timer operation and Timer period.

Load :Code Setting Function

The following input of a 4-digit code allows the configuration to be set directly, without the need to set each individual function.

Refer to p.51 for setting procedure

[FX-301(P)(-HS) Code Setting Table]

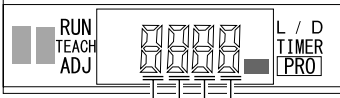

First digit				Second digit				Third digit				Fourth digit		
Direct code	Response Time	Hysteresis	Check	Direct code	L-ON / D-ON	Display	Check	Direct code	Adjust lock	Timer operation	Check	Direct code	Timer period	Check
0	STD	H-02 (standard)		0	L-ON	Incident light intensity		0	ON	NON (without timer)		0	OFF	
1	STD	H-03 (large)		1	L-ON	%		1	ON	OFF-delay		1	1 ms	
2	STD	H-01 (small)		2	L-ON	Peak hold		2	ON	ON-delay		2	3 ms	
3	LONG	H-02 (standard)		3	L-ON	Bottom hold		3	ON	ONE SHOT		3	5 ms	
4	LONG	H-03 (large)		4	D-ON	Incident light intensity		4	OFF	NON (without timer)		4	10 ms	
5	LONG	H-01 (small)		5	D-ON	%		5	OFF	OFF-delay		5	30 ms	
6	FAST	H-02 (standard)		6	D-ON	Peak hold		6	OFF	ON-delay		6	50 ms	
7	FAST	H-03 (large)		7	D-ON	Bottom hold		7	OFF	ONE SHOT		7	100 ms	
8	FAST	H-01 (small)						8				8	300 ms	
9	S-D	H-02 (standard)						9				9	500 ms	
													1 sec.	
													2 sec.	
													3 sec.	
													4 sec.	
													5 sec.	

[FX-305(P) Code Setting Table]

Output 1 only can be set.



First digit				Second digit				Third digit				Fourth digit		
Direct code	Response Time	Hysteresis	Check	Direct code	L-ON / D-ON	Display	Check	Direct code	Adjust lock	Timer operation	Check	Direct code	Timer period	Check
0	STD	H-02 (standard)		0	L-ON	Incident light intensity		0	ON	NON (without timer)		0	OFF	
1	STD	H-03 (large)		1	L-ON	%		1	ON	OFF-delay		1	1 ms	
2	STD	H-01 (small)		2	L-ON	Peak hold		2	ON	ON-delay		2	3 ms	
3	LONG	H-02 (standard)		3	L-ON	Bottom hold		3	ON	ONE SHOT		3	5 ms	
4	LONG	H-03 (large)		4	D-ON	Incident light intensity		4	OFF	NON (without timer)		4	10 ms	
5	LONG	H-01 (small)		5	D-ON	%		5	OFF	OFF-delay		5	30 ms	
6	FAST	H-02 (standard)		6	D-ON	Peak hold		6	OFF	ON-delay		6	50 ms	
7	FAST	H-03 (large)		7	D-ON	Bottom hold		7	OFF	ONE SHOT		7	100 ms	
8	FAST	H-01 (small)						8	ON	ON-delay • OFF-delay		8	300 ms	
9	H-SP	H-02 (standard)						9	ON	ON-delay • ONE SHOT		9	500 ms	
	U-LG	H-02 (standard)							OFF	ON-delay • OFF-delay			1 sec.	
	STDF	H-02 (standard)							OFF	ON-delay • ONE SHOT			2 sec.	
													3 sec.	
													4 sec.	
													5 sec.	

* In the event that the timer operation for ON-delay / OFF-delay or ON-delay / ONE SHOT (8~b) are both set using the 3rd digit, then the timer period setting selected by the 4th digit will be common to both timer operations.

[Notes]

- If function settings (Response time, Hysteresis, L-ON / D-ON, Display setting, Adjust lock setting function, Timer operation and Timer period) are changed, the changes will be reflected in the configuration and the numerical value of the direct code will be automatically updated as a result.
- If Timer operation is set to 'NON (without timer)', then the Timer period will be forced to change to OFF.
- If the Timer period in the fourth digit is set to 'OFF (code: 0)', then the Timer operation in the third digit will change automatically to NON (without timer) (code: 0 or 4).
- If the Timer period is set to a time that does not correspond to a direct code value, then the remaining codes, other than that in the fourth digit, will still remain valid. At this time, the digital display of the **FX-301** will indicate '----'.

:Adjust Lock Setting Function

Refer to p.52 for setting procedure

This function allows the selection of whether the 'threshold value fine adjustment mode' is enabled (Adjustment Lock OFF) or disabled (Adjustment Lock ON) in RUN mode (normal sensing operation).

When set to 'Adjust Lock OFF', the threshold value can be adjusted directly in 'RUN mode' (normal sensing operation).

:Setting Reset Function

Refer to p.53 for setting procedure

This function will cause all configuration settings to revert to factory settings. However, any settings that have been saved within the data bank will not be changed. Please refer to the '**3-2. Factory Settings**' on p.4.

:Interference Prevention Switching Function

Refer to p.54 for setting procedure
FX-305(P) only

The number of fibers that can be installed close together can be changed from 4 to 8. However, the response time will be twice as long.

If the response time is set to 'H-SP (ultra high-speed)', 2 units and 4 units can be set.

If the response time is set to 'U-LG (ultra long-range)', 8 units and 16 units can be set.

9-2. Code Setting Function

The input of a 4-digit code allows the configuration to be set directly, without the need to set each individual function. Output 1 only can be set for **FX-305(P)**.

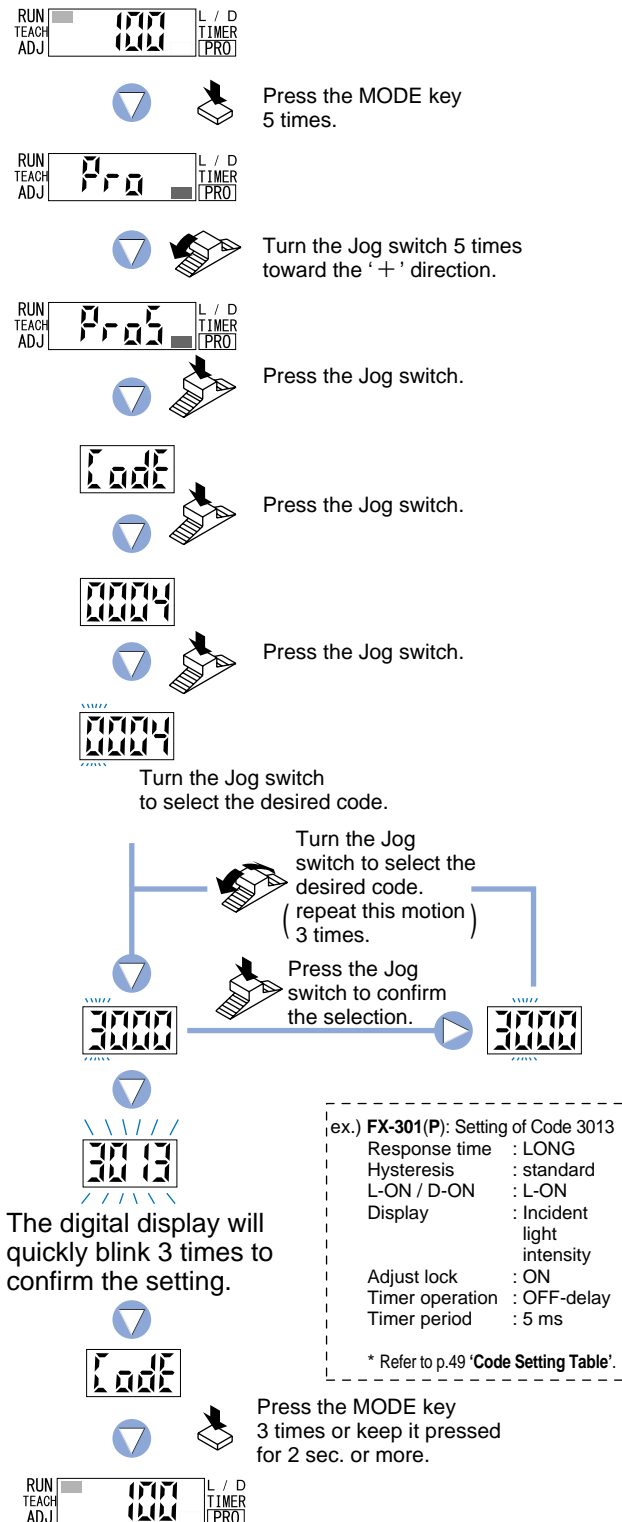

- ① Press the [MODE key] 5 times to select 'PRO mode'.
- ② Turn the [Jog switch] 5 times toward the '+' direction, to select 'PRO5 mode'.
- ③ Press the [Jog switch] to enter the 'code setting' state.
- ④ If the [Jog switch] is pressed, the current setting will be displayed.
* The factory setting is; **FX-301(P)**: '0004',
FX-301(P)-HS: '-004',
FX-305: '0004'
- ⑤ Press the [Jog switch] to input the 4-digit of the 'code'. Please refer to the 'Code Setting Table' on p.49, for information on inputting codes.
- ⑥ Repeat the following motions: Turn the [Jog switch] to select the digits, then press the [Jog switch] to confirm each selection. Once 4-digit have been input, the digital display will quickly blink 3 times, confirming the 'code' setting.
- ⑦ Press the [MODE key] 3 times or keep it pressed for 2 sec. or more, the amplifier will return to 'RUN mode' (normal sensing operation).

9-3. Adjust Lock Setting Function

This function allows the selection of whether the 'threshold value fine adjustment mode' is enabled (Adjustment Lock OFF) or disabled (Adjustment Lock ON) in RUN mode (normal sensing operation). When set to Adjust Lock OFF, the threshold value can be adjusted directly in 'RUN mode' (normal sensing operation).

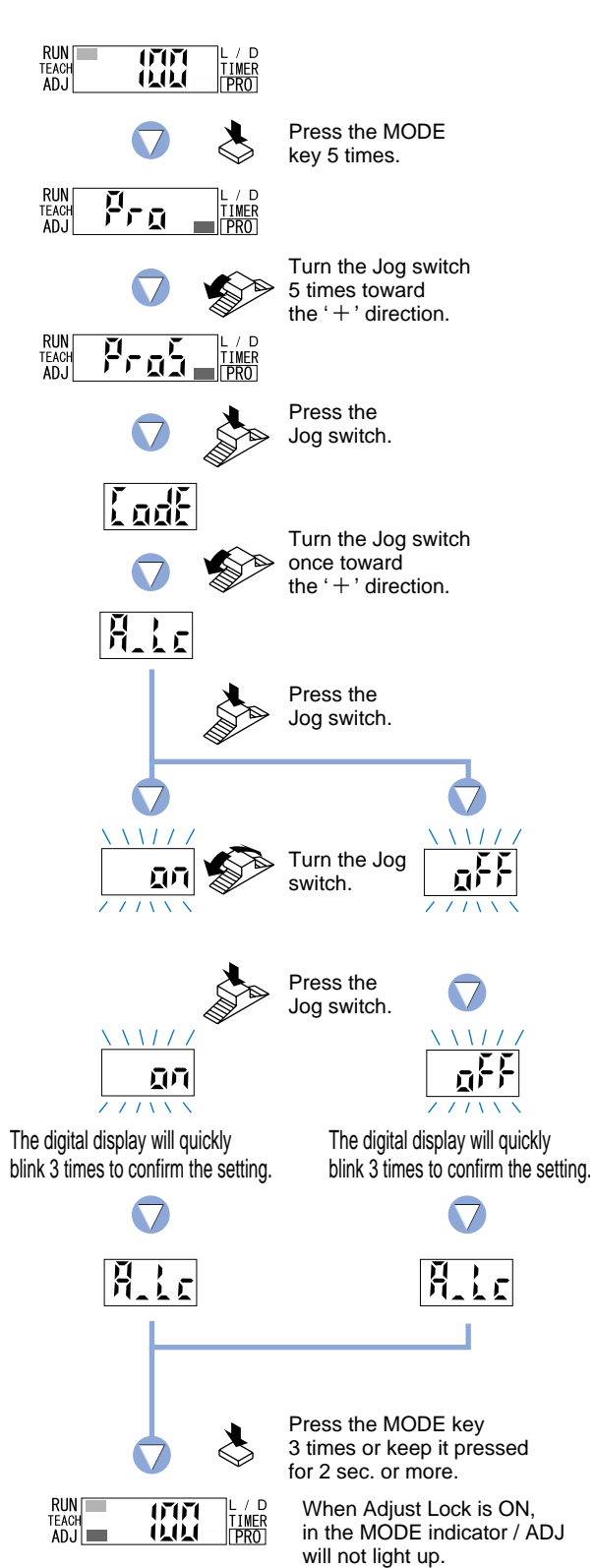

- ① Press the [MODE key] 5 times to select 'PRO mode'.
- ② Turn the [Jog switch] 5 times toward the '+' direction, to select 'PRO5 mode'.
- ③ Press the [Jog switch] to enter the 'code setting' state.
- ④ Turn the [Jog switch] once toward the '+' direction, to enter the 'adjust lock setting' state.
- ⑤ If the [Jog switch] is pressed, the current setting will be displayed.
* The factory setting is 'ON'.
- ⑥ If the [Jog switch] is turned, the digital display will blink. Select either 'ON' or 'OFF'. If 'OFF' is selected, operation of the threshold value fine adjustment is permitted during 'RUN mode'.
- ⑦ If the [Jog switch] is pressed, the digital display will quickly blink 3 times, confirming the setting.
- ⑧ Press the [MODE key] 3 times or keep it pressed for 2 sec. or more, the amplifier will return to 'RUN mode' (normal sensing operation).

9-4. Setting Reset Function

This function will cause all configuration settings to revert to factory settings. However, any settings that have been saved within the data bank will not be changed.

If the information stored within the data bank is to be changed, then data bank settings must be overwritten with new settings by using the '7-3. Data Bank Save Setting Function' from 'PRO3 Mode', described on p.42.



Press the [MODE] key 5 times.

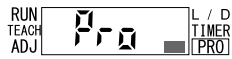

Turn the [Jog switch] 5 times toward the '+' direction.

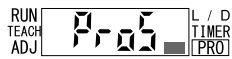

Press the [Jog switch].



Turn the [Jog switch] twice toward the '+' direction.

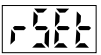

Press the [Jog switch].



Press the [Jog switch].

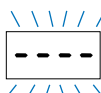

After the digital display will blink twice, the amplifier will automatically return to 'RUN mode'.



- ① Press the [MODE key] 5 times to select 'PRO mode'.
- ② Turn the [Jog switch] 5 times toward the '+' direction, to select 'PRO5 mode'.
- ③ Press the [Jog switch] to enter the 'code setting' state.
- ④ Turn the [Jog switch] twice toward the '+' direction, to enter the 'reset setting' state.
- ⑤ If the [Jog switch] is pressed, the letters '4E5' will be displayed.
- ⑥ If the [Jog switch] is pressed, all configuration settings to revert to factory settings.
- ⑦ After '----' blinks twice, the amplifier will automatically return to 'RUN mode' (normal sensing operation).

9-5. Interference Prevention Switching Function [FX-305(P) only]

The number of fibers that can be installed close together can be changed.

If the response time is set to H-SP (ultra high-speed), interference prevention can be used for up to 2 units for IP-1 (65 μ s) and up to 4 units for IP-2 (130 μ s).

If the response time is set to U-LG (ultra long-range), interference prevention can be used for up to 8 units for IP-1 (4.5 ms) and up to 16 units for IP-2 (9 ms).

This function is not equipped with the **FX-301(P)(-HS)**.

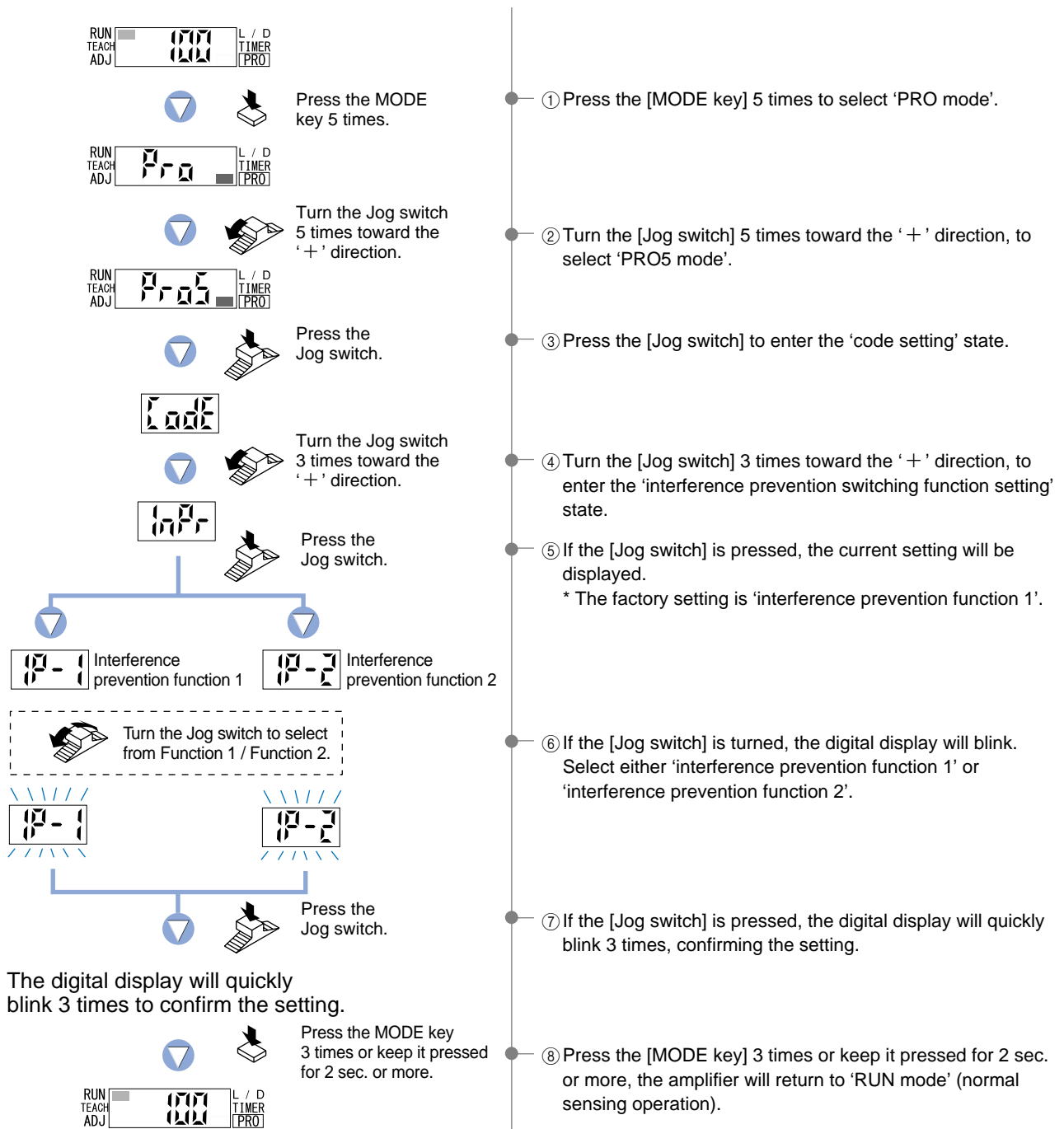

10 PRO6 Mode [FX-305(P) only]

10-1. PRO6 Mode Functions and Settings

PRO6 mode is exclusive to the **FX-305(P)**.

This mode allows both the sensing mode (Output 1: normal / window comparator / rising differential / trailing differential, Output 2: normal / alarm output / error output) and the hysteresis for window comparator mode to be configured.

<Can be set for output 1 and output 2>

 : **Normal Mode**

Refer to p.56~ for setting procedure

This is a sensing mode for setting a single 'threshold value' and turning output ON or OFF.

* The factory setting is 'normal mode'.

<Can only be set for output 1>

 : **Window Comparator Mode**

Refer to p.56~ for setting procedure

This is a sensing mode for setting two threshold values and tuning output ON or OFF within the set range.

The teaching method can be selected from 1-level teaching, 2-level teaching or 3-level teaching.

<Can only be set for output 1>

 : **Rising differential / Trailing differential Mode**

Refer to p.56~ for setting procedure

This is a mode for canceling out gradual changes in light amount, so that only sudden changes are sensed when the incident light amount increases or decreases.

<Can only be set for output 2>

 : **Alarm Output Mode**

Refer to p.58 for setting procedure

Drops in light amounts due to problems such as broken fibers or dirty tips are detected and output. If output 1 threshold value teaching is carried out, output 2 is set to the value of output 1 shifted by the set margin amount. This allows drops in margin light amounts due to dust or other particles to be detected and output.

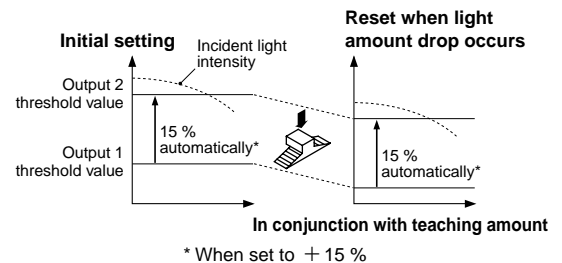



<Can only be set for output 2>

 : **Error Output Mode**

Refer to p.58 for setting procedure

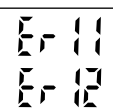
Output if the following errors occur.

Digital display	Error description	Measures
	The load has short-circuited and excess current is flowing. Er 11: Output 1, Er 12: Output 2	Turn off the power, then check the load.
	Communication error has occurred at time of connection. (In case of using functions) of PRO4 mode	Confirm that all amplifier units are properly connected to each other.

10-2. Output 1 Sensing Mode Settings

Output 1 can be set to one of four sensing modes (normal / window comparator / rising differential / trailing differential).

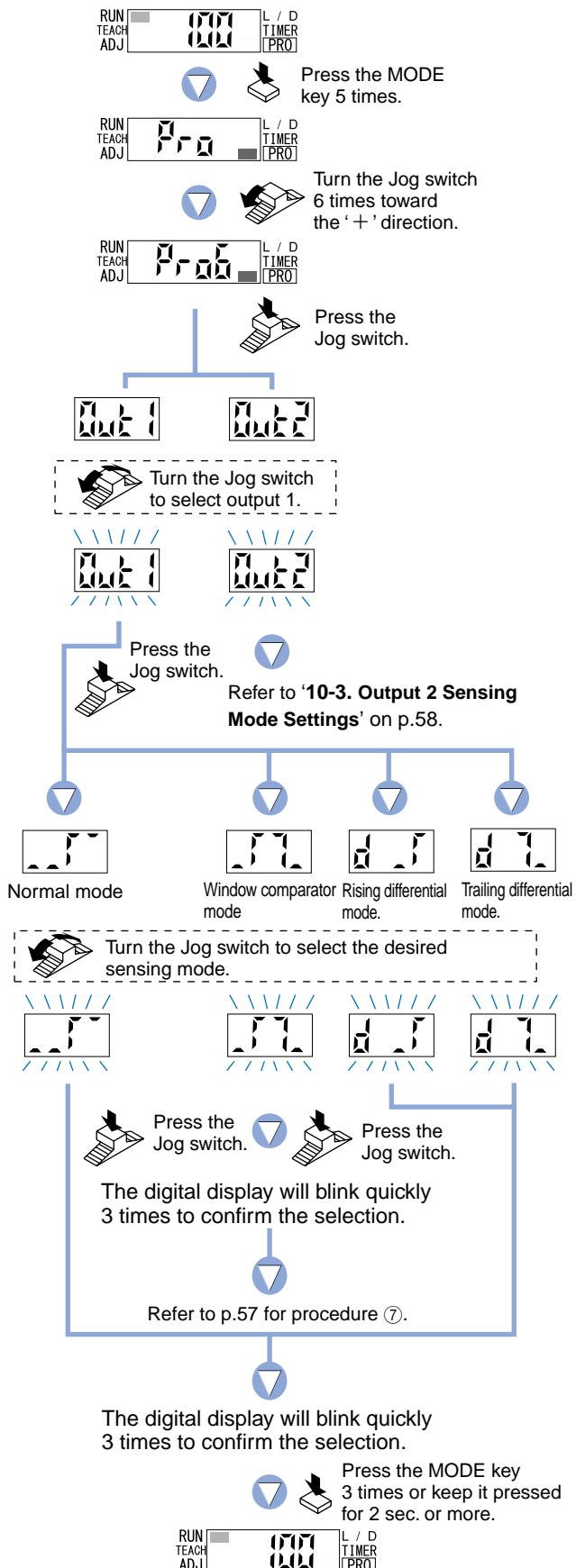

① Press the [MODE key] 5 times to select 'PRO mode'.

② Turn the [Jog switch] 6 times toward the '+' direction, to select 'PRO6 mode'.

③ Press the [Jog switch] to enter the 'output 1 / output 2 selection' state.

④ Turn the [Jog switch] to select the 'output 1 sensing mode setting'.

⑤ If the [Jog switch] is turned, the digital display will blink. Select the desired 'sensing mode'.
* The factory setting is 'normal mode'.

⑥ If selecting normal mode... If the [Jog switch] is pressed, the digital display will blink quickly 3 times to confirm the selection. And then press the [MODE key] 3 times or keep it pressed for 2 sec. or more, the amplifier will return to 'RUN mode' (normal sensing operation). (Refer to p.10 for teaching method.)

If selecting window comparator mode ...



If the [Jog switch] is pressed, the digital display will blink quickly 3 times and the unit will enter the 'teaching method selection' state.
* Refer to p.57 for procedure ⑦.

If selecting rising / trailing differential mode...



If the [Jog switch] is pressed, the digital display will blink quickly 3 times to confirm the selection. And then press the [MODE key] 3 times or keep it pressed for 2 sec. or more, the amplifier will return to 'RUN mode' (normal sensing operation). (Refer to p.12 for teaching method.)

Window comparator mode

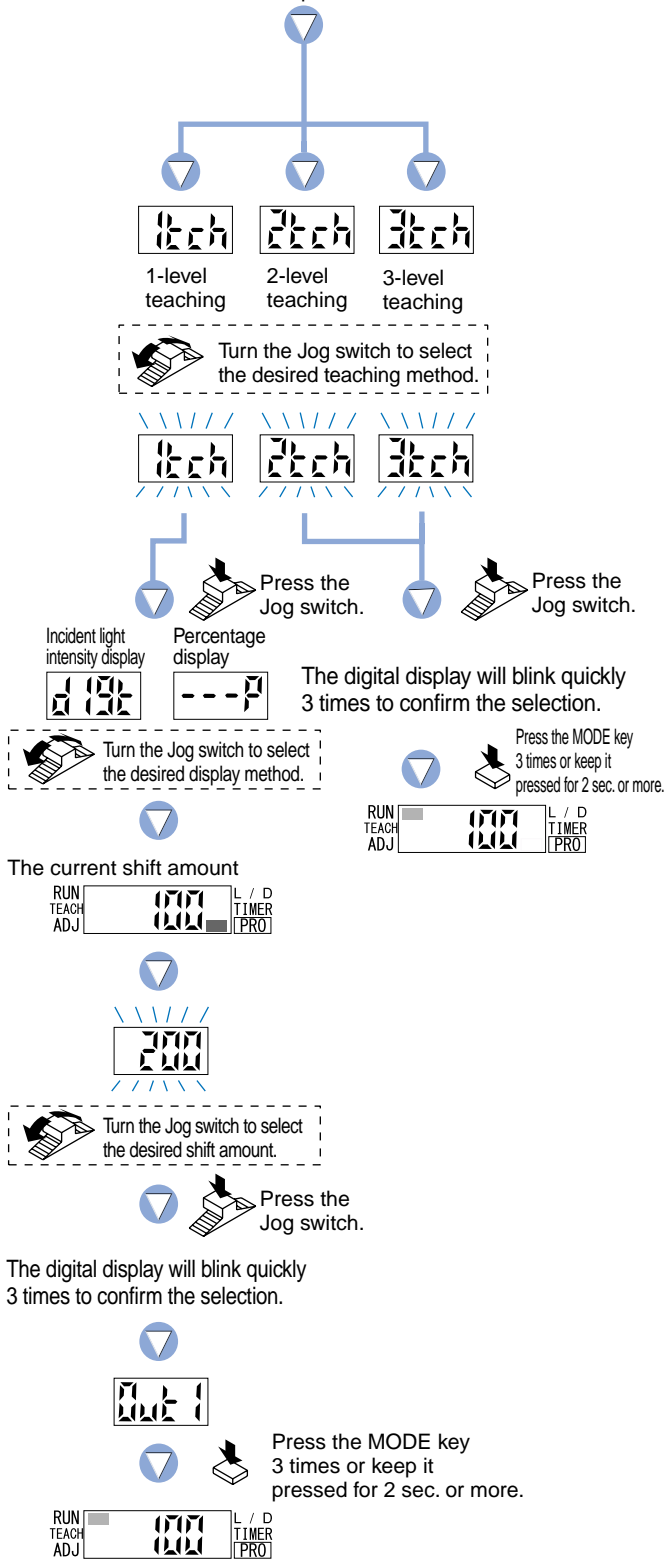

⑦ If the [Jog switch] is turned, the digital display will blink. Select the desired 'teaching method'.
* The factory setting is '1-level teaching'.

⑧ If selecting 1-level teaching in window comparator mode...
If the [Jog switch] is pressed, the unit will enter the 'display method' setting state. Turn the [Jog switch] to select the desired display method.
* The factory setting is 'incident light intensity display'.
If the [Jog switch] is pressed, the unit will enter the 'shift amount' selection state. Turn the [Jog switch] to select the desired shift amount.
* The factory setting for shift amount is '100'.
Refer to p.13~ for teaching method.

If selecting 2-level or 3-level teaching in window comparator mode

... If the [Jog switch] is pressed, the digital display will blink quickly 3 times to confirm the selection.
Refer to p.15~ / p.17~ for teaching method.

10-3. Output 2 Sensing Mode Settings

Output 2 can be set to one of three sensing modes (normal / alarm output / error output).

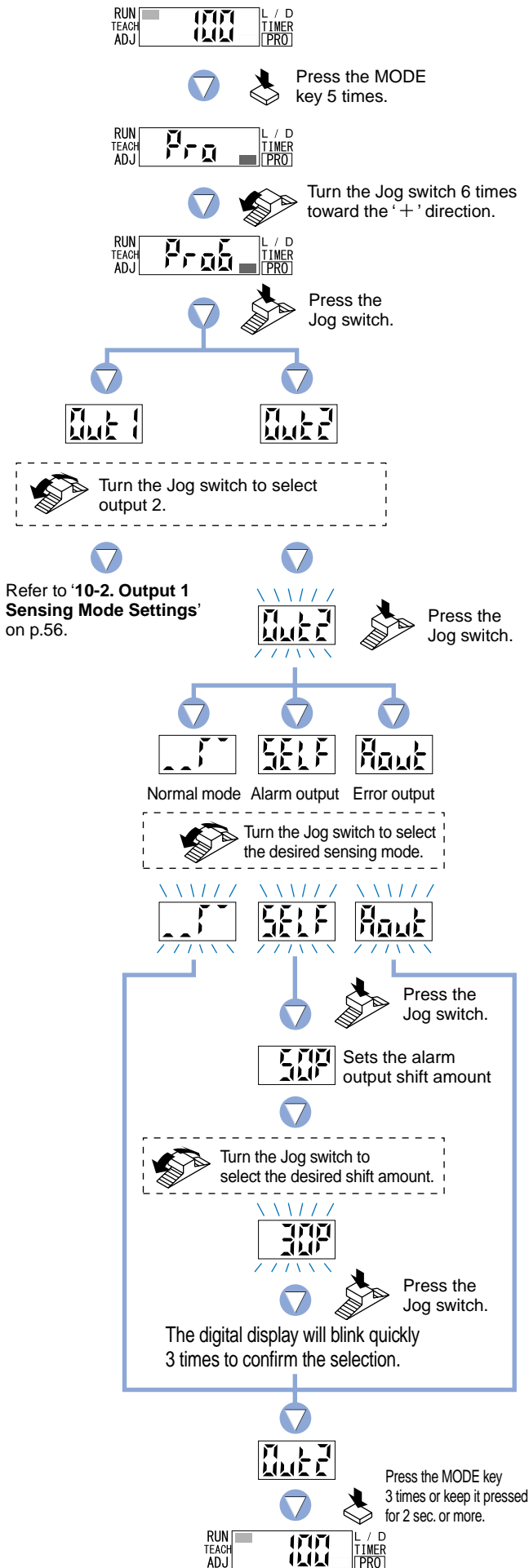

- ① Press the [MODE key] 5 times to select 'PRO mode'.
- ② Turn the [Jog switch] 6 times toward the '+' direction, to select 'PRO6 mode'.
- ③ Press the [Jog switch] to enter the 'output 1 / output 2 selection' state.
- ④ Turn the [Jog switch] to enter the 'output 2 sensing mode setting' state.
- ⑤ If the [Jog switch] is pressed, the current sensing mode will be displayed.
* The factory setting is 'normal mode'.
- ⑥ If the [Jog switch] is turned, the digital display will blink. Select the desired 'sensing mode'.
- ⑦ If the [Jog switch] is pressed, the digital display will blink quickly 3 times, confirming the 'sensing mode'.
- ⑧ If 'Alarm output mode' is selected, shift amount setting will be enabled. The level can be set to one of the following eight levels: 50 %, 30 %, 15 %, 10 %, -10 %, -15 %, -30 %, -50 %.
- ⑨ Press the MODE key 3 times or keep it pressed for 2 sec. or more, the amplifier will return to 'RUN mode' (normal sensing operation).

11 Others

11-1. Key Lock Function

The 'key lock function' prevents operators from changing the sensor settings by mistake.

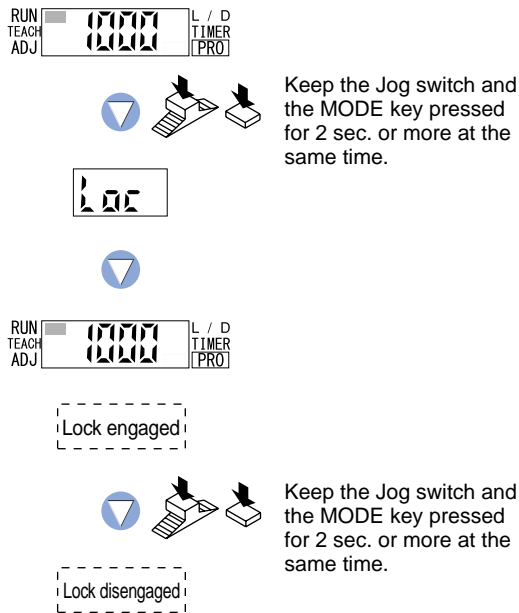

- ① Keep the [MODE key] and the [Jog switch] pressed for 2 sec. or more at the same time in 'RUN mode' condition.
- ② 'Loc' will be displayed, and the key lock function will be set to ON.
- ③ Key operations will be locked. Only the threshold value confirmation function or the adjust function (valid only when the adjust lock function is disengaged. Refer to p.53) is valid. If the key lock is engaged while the adjustment lock is disengaged (refer to p.53), it will only be possible to change the threshold value.
- ④ To disengage the lock function, keep the [MODE key] and the [Jog switch] pressed for 2 sec. or more at the same time once again.

* The threshold value confirmation function is a function for confirming the threshold value even during RUN mode. You can display the threshold value by turning the [Jog switch] in the '+' or '-' direction. (The threshold value cannot be changed at this time.) In addition, the original display reappears when you release the [Jog switch].

'+' direction: **FX-301 / FX-305** output 1 threshold value confirmation

'-' direction: **FX-305** output 2 threshold value confirmation

11-2. Threshold Value Confirmation Function

The threshold value confirmation function allows confirmation of the threshold values even during RUN mode.

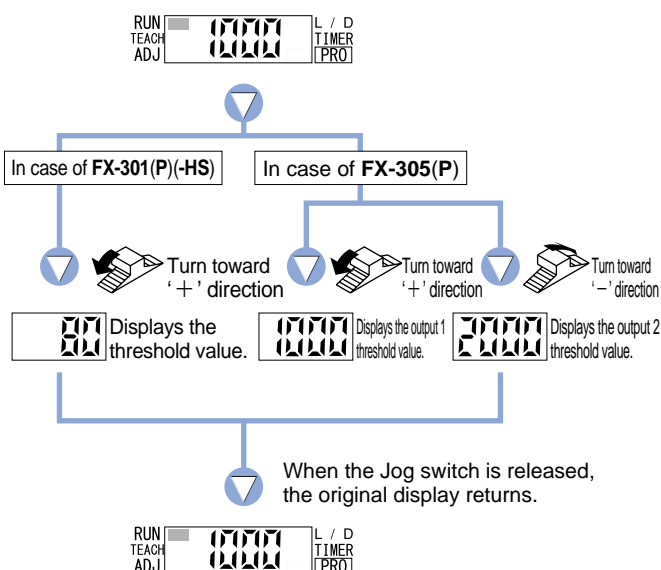

- ① When the Jog switch is turned toward the '+' direction, the threshold value [for the **FX-301(P)(-HS)**] or the output 1 threshold value [for the **FX-305(P)**] will be displayed. When it is turned toward the '-' direction, the output 2 threshold value [for the **FX-305(P)**] will be displayed.
- * If the **FX-305(P)** is set to window comparator mode, the lower limit value will be displayed when the Jog switch is turned once toward the '+' direction, and the upper limit value will be displayed when it is turned once more.